

Phason

← Status 14:57:29

STG2 24-in

Zone 1 72.3 °F		Outdoor 72.8 °F
Set Point 71.5 °F		Status 40 %

← STG1 36-in  Inlets →

 **SUPRA**
TOUCH SERIES

Table of contents

Chapter 1: Introducing Supra Touch	4
Getting to know Supra Touch.....	4
Capabilities	5
Becoming familiar with Supra Touch	6
Unlocking the screen	7
Chapter 2: Installing the Supra Touch	8
What you need to know before installing the Supra Touch	8
Understanding power surges and surge suppression	8
Reducing electrical noise using filters	8
Electrical ratings	10
Using power contactors to increase the capacity of relays.....	10
Bottom layout.....	11
Cover layout.....	12
Mounting the Supra Touch	13
Connecting equipment to the Supra Touch	13
Connecting actuators (inlets with feedback)	13
Connecting curtain machines.....	15
Connecting fixed-speed cooling or heating equipment and air curtains	16
Connecting variable heating or cooling equipment	17
Using three-phase power	18
Connecting an alarm system.....	18
Connecting sensors.....	19
Connecting the power source	23
Finishing the installation	23
Chapter 3: Configuring your Supra Touch	24
Configuring the main control functions	25
Setting the clock	25
Selecting the units of measure	25
Configuring hysteresis	25
Configuring relay stagger	26
Configuring alarm silencing.....	27
Configuring the zone control mode.....	27
Configuring sensor inputs	28
Configuring equipment.....	30
Configuring variable stages	30
Configuring relays.....	31
Configuring relays for inlet actuators or curtains.....	32
Calibrating inlet actuators.....	33
Configuring relays for air curtains.....	33
Chapter 4: Programming the Supra Touch	34
Before you program the Supra Touch.....	34
Programming zone settings	36
Programming the master set point	36
Programming growth curves	37
Programming minimum ventilation curves	39
Programming modifiers	41

Programming alarms	43
Programming equipment settings	45
Programming merged ventilation	45
Programming variable cooling stages	47
Programming variable heating stages	48
Programming inlet actuators	50
Programming curtain control relays	52
Programming air curtains	53
Programming relay stages	60
Programming duty cycles	61
Using settings groups	63
Chapter 5: Monitoring and maintaining your Supra Touch	65
Monitoring the Status screen	65
Widgets	66
Acknowledging alarms	66
Testing sensors and equipment	67
Using manual override	67
Testing a zone's sensors and equipment	68
Using screen lock security	68
Servicing and maintaining your Supra Touch	69
Restoring the factory defaults	69
Saving and restoring settings	70
Displaying version information	71
Updating the firmware	71
Replacement kits and optional accessories	72
Appendixes	75
Appendix A: Troubleshooting	75
Determining correct actuator feedback wiring	78
Appendix B: Factory defaults	79
Appendix C: Worksheets	80
Installation worksheets	80
Configuration worksheets	82
Settings worksheets	85
Appendix D: Motor curves	92

Chapter 1: Introducing Supra Touch

Getting to know Supra Touch

Supra Touch is a powerful yet easy-to-use climate controller for up to four independent zones. It monitors conditions in each zone and operates equipment such as fans, heaters, inlets, and curtains to provide the optimal environment you need.

Secondary modifiers

Supra Touch is more than a temperature-based control. You can measure other conditions such as humidity, ammonia, carbon dioxide, and wind speed. Secondary modifiers allow you to use these measurements to influence how Supra Touch controls equipment. For example, if the humidity is too high you can have the control switch on heaters and/or increase ventilation to reduce it.

VentGrid™

In addition to traditional staged control, Supra Touch offers VentGrid merged mode. VentGrid has up to 10 steps that can provide smoother transitions between steps than staged mode can between stages.

Curves

Growth and minimum ventilation curves allow you to automatically change the temperature set point and minimum ventilation rate over time to adjust to requirements as your animals grow.

Easy to program, manage, and monitor

The touchscreen display allows you to easily configure, program, and check the status of zones and equipment. From the status screen, you can easily access configuration, settings, and more. Every powerful feature is never more than a few taps away. This makes the Supra Touch one of the easiest-to-use and user-friendly controls.

Security and peace of mind

Supra Touch has a screen lock security system. While screen lock is enabled, users can view the status screen but must enter the PIN before they can access any of the control's functions.

Supra Touch is compatible with most alarm systems. You can connect the control to an alarm siren or other external alarm system. Customizable alarm settings allow you to choose which alarm conditions you want to be notified about.

Capabilities

Programming options		
Automatic temperature control	✓	-13 to 125°F (-25 to 51°C)
Independent control zones	4	
Staged ventilation mode	✓	
VentGrid™ merged ventilation mode	✓	10 steps
Manual override mode	✓	
Growth curves	4	
Minimum ventilation curves	4	
Secondary modifiers	✓	
Settings groups	✓	
Relay stagger for distributing startup load	✓	
Hysteresis	✓	
Stages and relays		
Variable AC stages	4	
0 to 10 V DC signal outputs	4	With optional VDC-4 module
General-purpose relays	12	
Alarm relay	✓	
Variable and relay configuration options		
Variable cooling and heating	✓	
Relay cooling and heating	✓	
Duty cycle	✓	
Actuator / inlet	✓	Up to 2
Curtain machine / winch	✓	Up to 6
VFD control	✓	
Sensor inputs		
Phason 3K Series temperature inputs	5	30-ft. sensor included
Outdoor temperature	✓	
Phason humidity sensor	✓	
DOL 114 temperature and humidity	✓	
DOL 16 light	✓	
DOL 19 carbon dioxide (CO2)	✓	
DOL 53 ammonia (NH3)	✓	
Pulse counter	✓	Wind speed or water usage
Other		
5-inch touchscreen	✓	
Scrolling status screen	✓	
Updatable firmware	✓	Via USB
Transferable settings	✓	Via USB
Diagnostics	✓	
Hourly and daily logs	✓	
NEMA 4X enclosure	✓	Corrosion-resistant, water-resistant, and fire-retardant
CSA approval	✓	
2-year warranty	✓	

Becoming familiar with Supra Touch



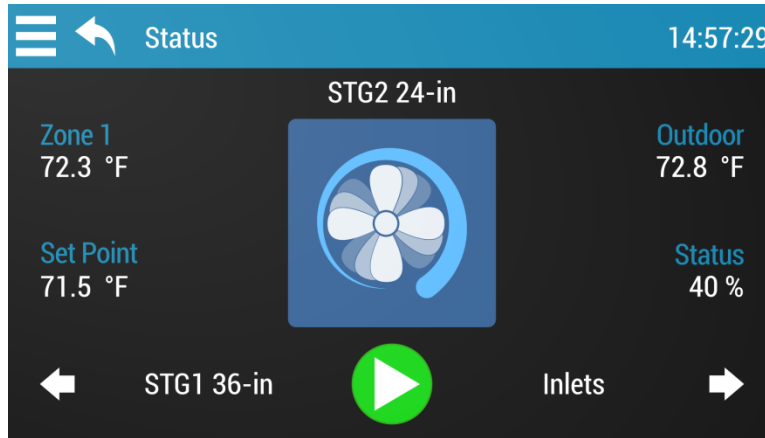







The Status screen is the “home” screen. Here you can find all basic information at a quick glance.



From the status screen, you can easily access configuration, settings, and more by pressing the menu in the top left corner. Every powerful feature is never more than a few taps away. This makes the Supra Touch one of the easiest-to-use and user-friendly controls. For more information about the status screen, read **Monitoring the Status screen** on page 65.

Icons

Here is a list of common icons you will use to interact with your Supra Touch.

	HOME Go to the status screen.		SAVE Save changes.
	MENU Go to Manual Override, Settings, Configuration, Administration, Screen Lock, and About Menus.		CANCEL Discard changes and return to the previous screen.
	BACK Go to the previous screen.		PLAY Play / resume the status screen.
	UP/DOWN Increase / decrease values.		PAUSE Pause the status screen.
	LEFT / RIGHT Move / scroll through zones, equipment, or sensors.		ALARM View the active alarm condition.
	UNLOCK Enter the PIN to unlock the screen.		

Menu layout

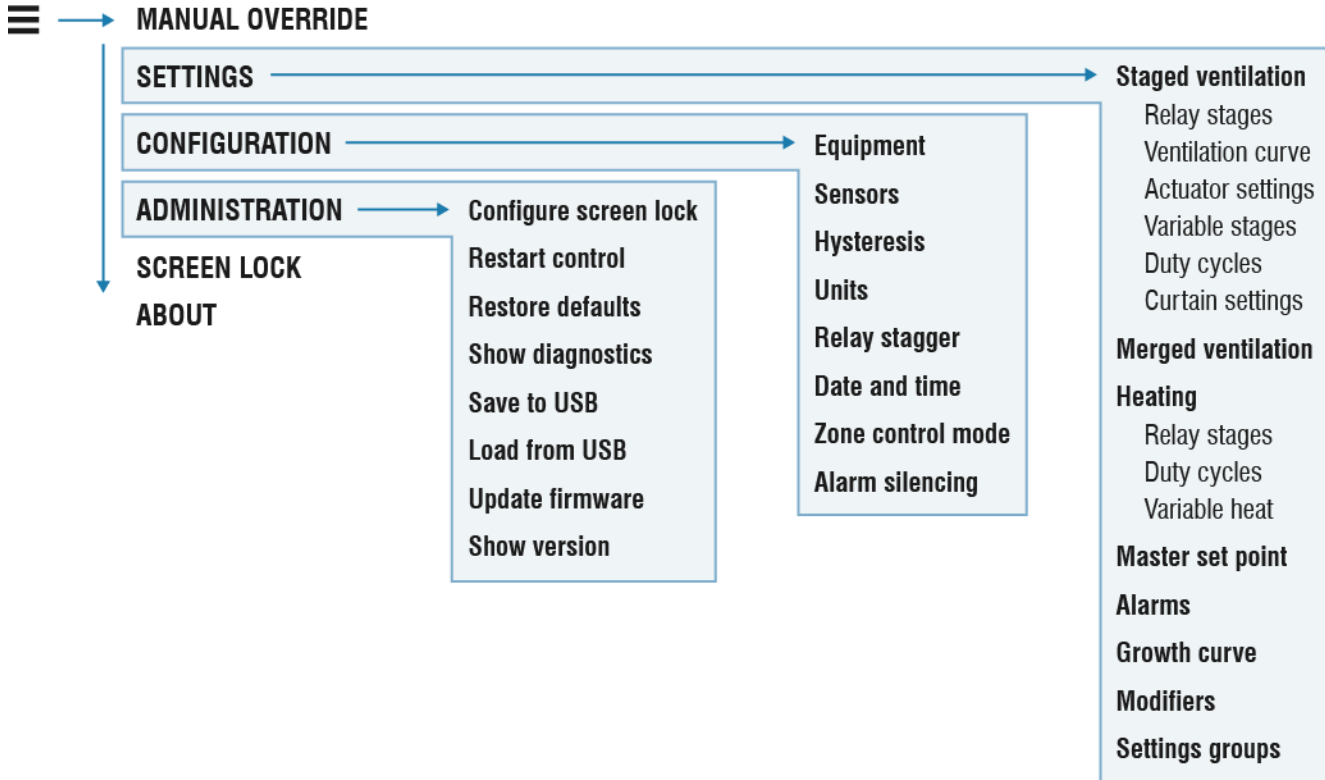

If you leave the control in a menu or screen other than Status, the control returns to the Status screen after five minutes without any key presses.

Unlocking the screen

Screen lock security is a feature you can use to control who makes changes to the control's settings. The default setting for screen lock is *not enabled*.

When screen lock is enabled, users must enter the PIN before they can access the any of the control's functions except the home screen. For more information, read **Using screen lock security** on page 68.

To unlock the screen

1. Press the **Lock** and then enter the four-digit PIN.
2. Press **Unlock Screen**.

Chapter 2: Installing the Supra Touch

What you need to know before installing the Supra Touch

1. Read **Understanding power surges and surge suppression** below.



- ◇ If you do not install external surge suppression devices, you risk damage to the electronics inside the Supra Touch, which may cause the Supra Touch to fail.
- ◇ Because it is not possible to **completely** protect this product internally from the effects of power surges and other transients, we **highly recommend** that you install external surge suppression devices. For specific recommendations, see your electrical contractor.
- ◇ If you do not take these precautions, you acknowledge your willingness to accept the risk of loss or injury.

2. List all the equipment you want to control on the **Installation worksheets** (starting on page 80). Install the equipment and make your electrical connections according to the sheet.
3. Use the installation worksheets to complete the **Configuration worksheets** (starting on page 82). List the equipment that is connected to each of the terminals and how you want it configured.

Understanding power surges and surge suppression

Power surges can be caused by external influences (influences outside the barn; for example, lightning or utility distribution problems) or they can be caused internally (inside the barn; for example, starting and stopping inductive loads such as motors).

One of the most common causes of power surges is lightning. When lightning strikes the ground, it produces an enormously powerful electromagnetic field. This field affects nearby power lines, which transmit a surge to any device connected to it, such as lights, computers, or environmental controls like the Supra Touch. Lightning does not have to strike a power line to transmit a surge.

Surge suppression devices offer some protection from power surges. Because it is not possible to internally protect this product completely from the effects of power surges and other transients, Phason **highly recommend** that you install external surge suppression devices. For specific recommendations, see your electrical contractor. If you do not take these precautions, you acknowledge your willingness to accept the risk of loss or injury.

Reducing electrical noise using filters

Electrical noise is caused by high voltage transients created when inductive loads, such as power contactors, are switched on or off. The strength of the transients can be over 1000 volts and can vary with the type of equipment and wiring, as well as several other factors.

Visible symptoms of electrical noise include erratic control operation, cycling inlets, communication problems, and more. However, the **effects of electrical noise are not always visible**. Over time, electrical noise can cause electronic circuits, relay contacts, and power contactors to deteriorate.

Installing filters helps extend the life of equipment

Filters help prevent electrical noise problems by absorbing the transient energy. Even if you do not have **visible symptoms** of electrical noise, filters help keep controls operating reliably and can extend the life of the controls and equipment connected to them.

Phason’s snubber filters (**model 127-0**) are for use with solenoids, timer relays, DC motors, furnaces, and other equipment connected to the control’s relays. You can also use the filters with loads connected to power contactors.

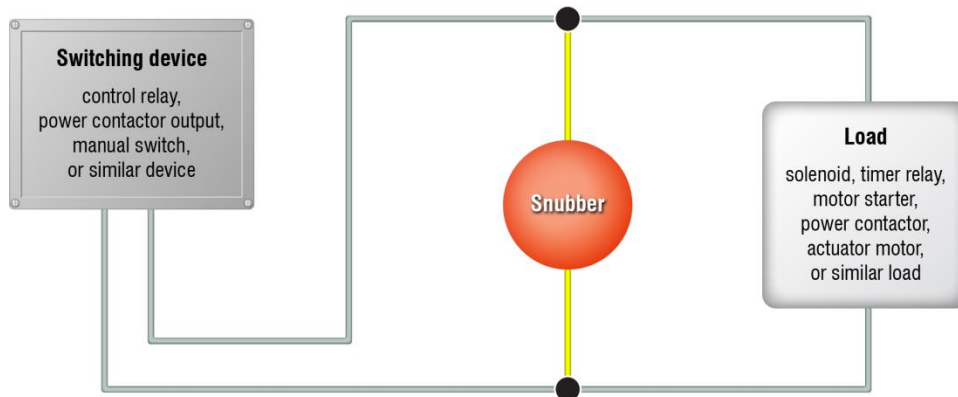

- ◇ Do not use Snubber filters with variable stages.
- ◇ Some power contactors include snubber filters. For more information, read **Using power contactors to increase the capacity of relays** on page 10.
- ◇ For more information about snubber filters or other Phason accessories, see your dealer or visit www.phason.ca.

Electrical ratings

Input power	120/230 VAC, 50/60 Hz
Variable AC stages ①	10 A at 120/230 VAC, general-purpose (resistive) 7 FLA at 120/230 VAC, PSC motor 1/2 HP at 120 VAC, 1 HP at 230 VAC, PSC motor
Fuses [4: F1 to F4]	15 A, 250 VAC ABC-type ceramic
Relays ① [12: RLY1 to RLY12]	10 A at 120/230 VAC, general-purpose (resistive) 1/3 HP at 120 VAC, 1/2 HP at 230 VAC 360 W tungsten at 120 VAC
Alarm relay	0.4 A at 125 VAC; 2 A at 30 VDC, resistive load 0.2 A at 125 VAC; 1 A at 30 VDC, inductive load

① You can connect more than one piece of equipment to a variable stage or relay as long as they are the same type (for example, two fans) and the total current draw does not exceed the stage's limit.



The FLA (full load ampere) rating accounts for the increase in motor current draw when the motor operates at less than full speed. Make sure the motor/equipment connected to the variable stage does not draw more than 7 FLA.

Using power contactors to increase the capacity of relays

Phason's Manual Override Box (**model MOB-4**) has four 240-volt power contactors that allow you to increase the load handling capability of control relays. Manual Override Box is ideal for secondary ventilation fans and electric heaters.

MOB-4 electrical ratings

- ◆ Coil: 10.2 mA at 240 VAC
- ◆ Contact: 25 A at 240 VAC; resistive
2 HP at 240 VAC, 1 HP at 120 VAC; motor, power factor 0.4
1300 W at 120 VAC; tungsten

For more information, read **Replacement kits and optional accessories** on page 72 .

Bottom layout

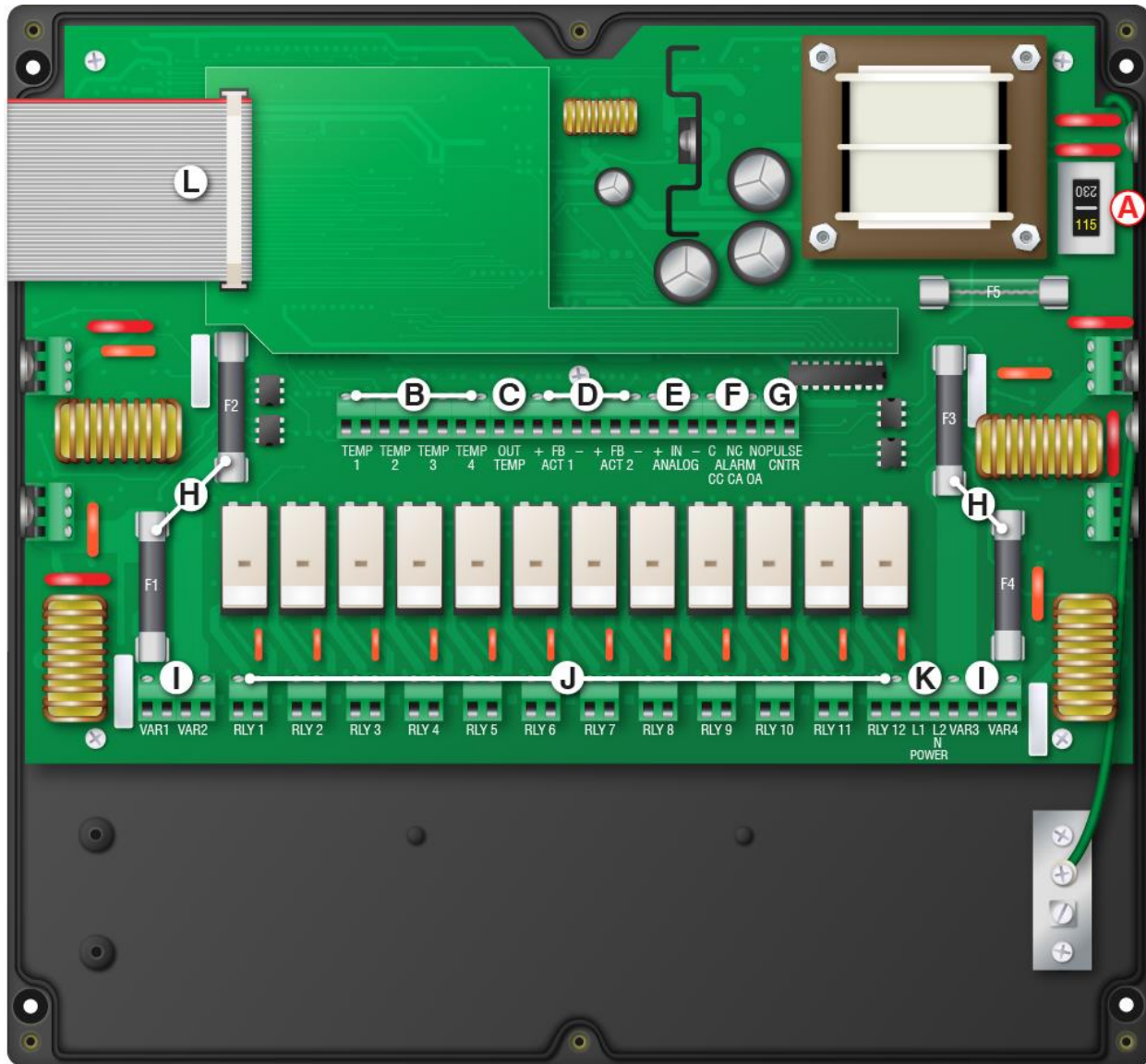

- (A) **Voltage switch:** ⚠ Set the switch to the correct line voltage.
- (B) **Temperature [TEMP1 to TEMP4]:** Connect 3K Series temperature sensors for monitoring zone temperatures.
- (C) **Outdoor temperature [OUT TEMP]:** Connect a 3K Series sensor for monitoring outdoor temperatures.
- (D) **Actuator feedback [ACT1 and ACT2]:** Connect the feedback potentiometers from actuators that require it.
- (E) **Humidity [ANALOG]:** Connect a Phason RHS Relative Humidity Sensor.
- (F) **Alarm relay:** Connect an external alarm system or siren.
- (G) **Not used**
- (H) **Fuses [F1 to F4]:** Fuses for variable stages: F1 for VAR1, F2 for VAR2, and so on.
- (I) **Variable stages [VAR1 to VAR4]:** Connect variable speed fans or heating equipment.
- (J) **General-purpose relays [RLY1 to RLY12]:** Connect single stage (on or off) equipment to these terminals.
- (K) **Incoming power:** Connect the incoming power from the panel.
- (L) **Display cable:** Disconnect the cable during installation. Reconnect it when done.

Cover layout

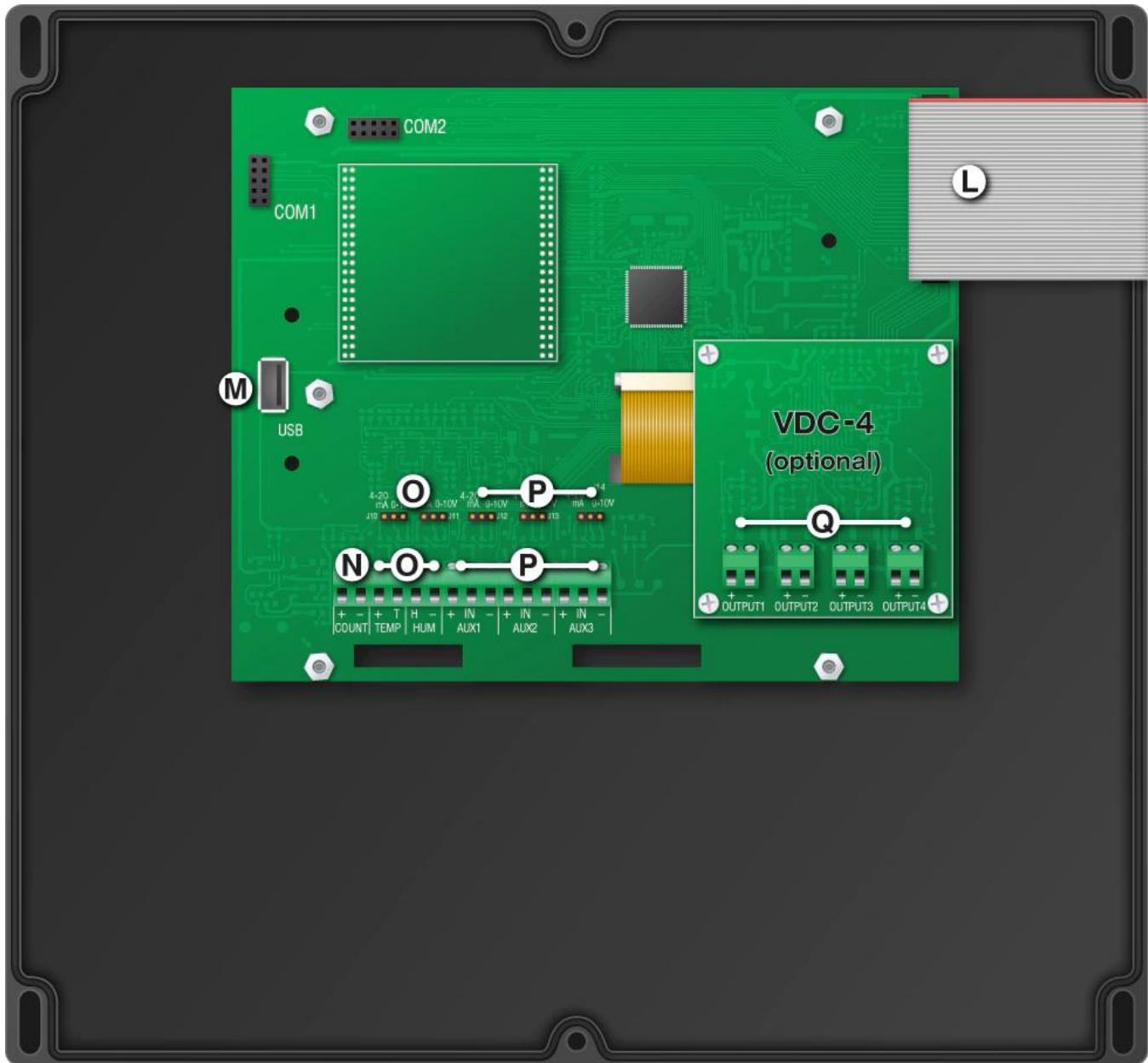

(L) Display cable: Disconnect the cable during installation. Reconnect it when done.

(M) USB: Connect a USB drive when saving / loading settings or upgrading.

(N) Pulse counter [COUNT]: Connect a WINDSPEED-03 sensor or water meter here.

(O) DOL 114 [TEMP / HUM]: Connect a DOL 114 Temperature and Humidity Sensor. Place the jumpers on the correct pins.

(P) DOL [AUX1 to AUX3]: Connect DOL 16 Light, DOL 19 Carbon Dioxide, or DOL 53 Ammonia Sensors. Place the jumpers on the correct pins.

(Q) VDC-4 [OUTPUT1 to OUTPUT4]: Connect variable frequency drives (VFDs) or other equipment that requires a 0 to 10 V DC signal input.

Mounting the Supra Touch

1. Select a location for the Supra Touch. Make sure you have enough cable and wire to reach all the equipment that you want to control.
2. Remove the screws from the front cover and then gently lift it off.
3. Mount the enclosure to a wall using the four screws provided with the control. Insert the screws into the large holes in each corner of the box and tighten.

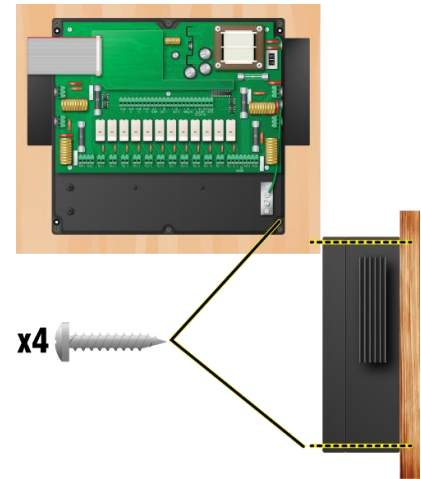

Connecting equipment to the Supra Touch

Follow these instructions when installing the Supra Touch and connecting equipment to it.



- ◇ Use the electrical knockouts for bringing wires or cables into or out of the Supra Touch enclosure. Do not make additional holes in the enclosure; this can damage the watertight seal or control components and void the warranty.



- ◇ Supra Touch test modes are useful for testing your equipment after installing and configuring it. For more information, read **Testing sensors and equipment** on page 67.
- ◇ If you used the Installation worksheets on page 80 when preparing, refer to them when installing equipment.

Connecting actuators (inlets with feedback)

In Supra Touch, actuators are considered “**inlets with feedback**”. Linear actuators are connected to inlets either directly or with cables and pulleys. Inlets are generally located in the ceiling or walls. Inlet systems are usually spring loaded to aid in closing the inlet or counter weighted to aid in opening the inlets.

You can connect two actuators to a Supra Touch. Each inlet requires two relays: one for opening and one for closing. We recommend choosing relays that are side-by-side.



If your actuators *do not* require feedback, it is considered a curtain, or, “inlet without feedback”. For more information, read **Configuring relays for inlet actuators or curtains** on page 32.

Feedback potentiometers

Each actuator you connect must have a feedback potentiometer. The feedback potentiometer, which you connect to one of the two corresponding feedback terminals, lets the control know how far the actuator's arm is extended.

Most linear actuators are available with potentiometer feedback and internal adjustable limit switches. A 10,000 ohm, 10 turn feedback potentiometer is preferred, but the internal feedback potentiometer can range between 1000 and 20,000 ohms. Potentiometers outside of this range will affect the precision to which the Supra Touch can control the actuator.

- ◇ A system operates more precisely when using the largest amount of stroke that is feasible with the actuator. The stroke is the distance the actuator arm extends or retracts.
- ◇ If you are unsure of the potentiometer wiring for your actuator, read **Determining correct actuator feedback wiring** on page 78.
- ◇ When routing the actuator feedback wires, do not run them in or along the same conduit as AC-power lines. Follow the guidelines in the **Control fundamentals guide**.
- ◇ If you are measuring AC power with a digital multimeter (DMM), note that if a limit switch opens the circuit, the DMM measures voltage after the relay switch even if the relay is open.



The ratings of the actuator must not exceed the ratings of the Supra Touch.
Supra Touch relay ratings: 10 A at 120/230 VAC, general-purpose (resistive)
 1/3 HP at 120 VAC, 1/2 HP at 230 VAC
 360 W tungsten at 120 VAC

To connect actuators

Connect actuators as shown below. Refer to your actuator's installation guide for information about its power supply requirements.

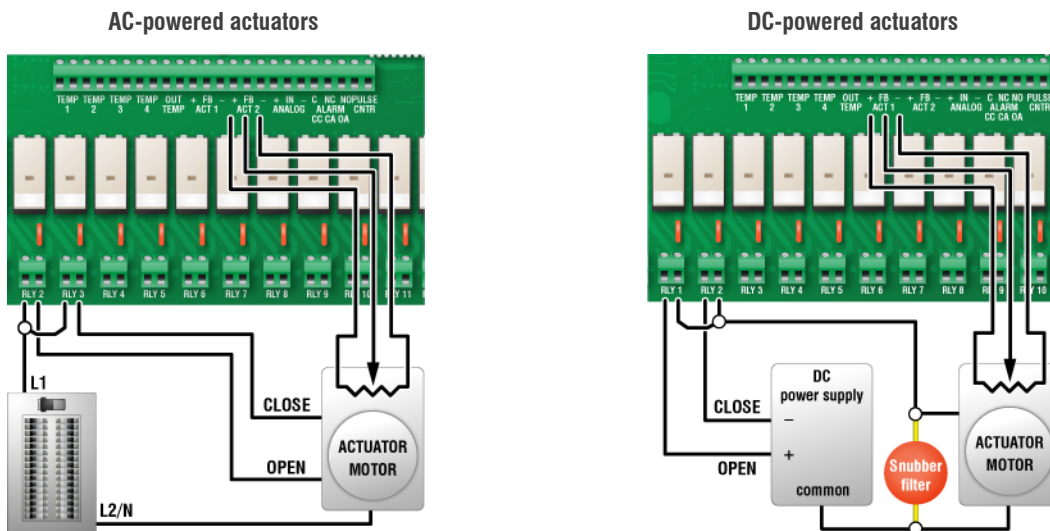

Connecting curtain machines

Curtains are usually controlled by equipment called curtain machines, which are sometimes referred to as winches. Curtains are opened and closed to let in more air or less air, the idea being more air cools the building.

Each curtain machine you connect requires two relays: one for opening the curtain and one for closing the curtain.



- ◇ In Supra Touch, curtains are considered “inlets without feedback”. If yours *does* require feedback, it is considered an actuator, or, “inlet with feedback”. For more information, read **Configuring relays for inlet actuators or curtains** on page 32.
- ◇ For connecting air curtains, see **Connecting fixed-speed cooling or heating equipment and** on page 16.



- ◇ The ratings of the equipment must not exceed the ratings of the Supra Touch relays.
Relay ratings: 10 A at 120/230 VAC, general-purpose (resistive)
 1/3 HP at 120 VAC, 1/2 HP at 230 VAC
 360 W tungsten at 120 VAC

To connect curtain machines

Connect curtain machines to the Supra Touch as shown.

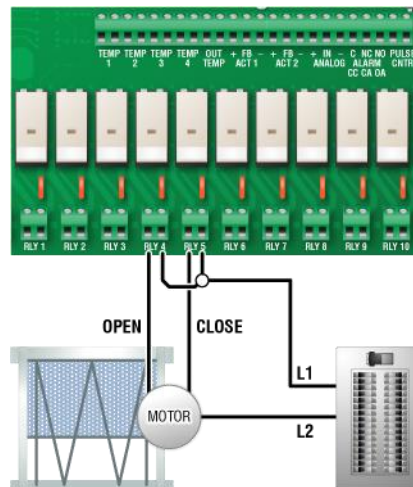

Connecting fixed-speed cooling or heating equipment and air curtains

Fixed-speed heating or cooling equipment includes electric heaters, furnaces, single-speed fans, and any other equipment that is either on or off.

- ◇ The ratings of the equipment must not exceed the ratings of the Supra Touch relays.

Relay ratings: 10 A at 120/230 VAC, general-purpose (resistive)
 1/3 HP at 120 VAC, 1/2 HP at 230 VAC
 360 W tungsten at 120 VAC



- ◇ Gas furnaces using hot-surface ignition or glow plug can draw more current than indicated on their nameplate and require power contactors. For more information, read your furnace dealer.

To connect equipment to relays

Connect equipment as shown below.

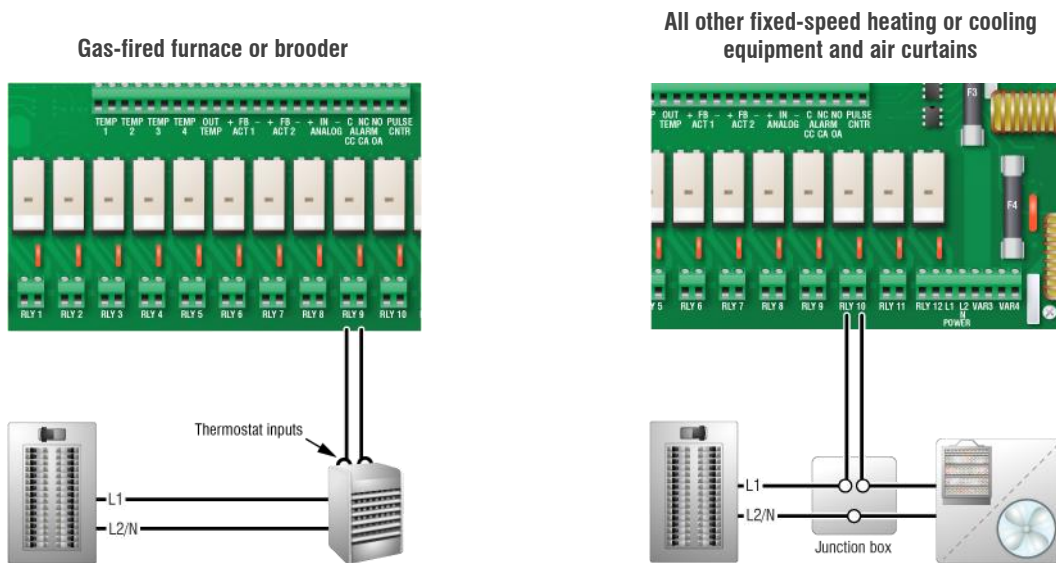

Connecting variable heating or cooling equipment

Variable cooling equipment includes equipment such as variable-speed fans. Variable heating equipment includes equipment such as heat mats and heat lamps.

- ◇ Only permanent split capacitor motors appropriate for variable speed control, or shaded pole motors, can be used on the variable stages.
- ◇ If you are using three-phase power, connect the Supra Touch and the variable cooling equipment to the same phase. For more information, read **Using three-phase power** on page 18.
- ◇ The ratings of the equipment must not exceed the ratings of the Supra Touch' variable stages.



Variable stage ratings: 10 A at 120/230 VAC, general-purpose (resistive)
 7 FLA at 120/230 VAC, PSC motor
 1/2 HP at 120 VAC, 1 HP at 230 VAC, PSC motor

Variable stage fuses: 15 A, 250 VAC ABC-type ceramic

To connect equipment to variable stages

Connect variable heating or cooling equipment as shown below.

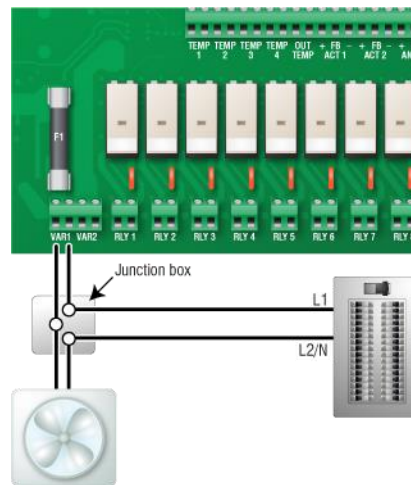

Using three-phase power

If you are connecting the Supra Touch to a three-phase system, make sure to connect the control power and the variable cooling equipment to the **same phase**. The control must be powered from the same phases that supply the equipment. If the control and the variable stages are wired to different phases, the equipment will operate erratically.

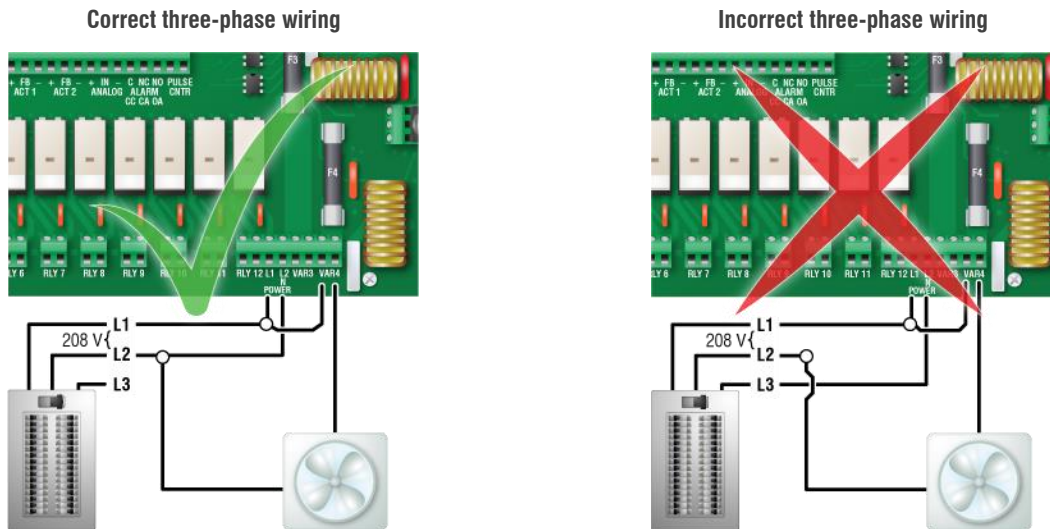

Connecting an alarm system

You can connect an alarm system to the alarm terminal on the Supra Touch. The alarm system can be a siren, alarm panel, auto-dialer, or similar equipment. Read your equipment's installation guide for information about the type of system: **normally open** or **normally closed**. Below are the descriptions for the alarm terminal.

- ◆ **C / CC:** common connection
- ◆ **NC / CA:** closed on alarm
- ◆ **NO / OA:** open on alarm

For the alarm system to sound (or dial out) during an alarm condition, you must enable the alarms. For more information, read **Programming alarms** on page 43.



The ratings of the siren or alarm system must not exceed the ratings of the Supra Touch' alarm relay.

Alarm relay ratings: 0.4 A at 125 VAC; 2 A at 30 VDC, resistive load
0.2 A at 125 VAC; 1 A at 30 VDC, inductive load

To connect a normally open alarm system

If you are connecting an alarm system with a normally open connection, meaning it closes when there is an alarm, connect it as shown in the normally open diagram.

If you are connecting the alarm system to more than one Supra Touch, join all the **CC** connections together and all the **OA** connections together. The alarm relays must be in parallel with each other so any of the controls can trigger the alarm system when an alarm occurs.

To connect a normally closed alarm system

If you are connecting an alarm system with a normally closed connection, meaning it opens when there is an alarm, connect it as shown in the normally closed diagram.

If you are connecting the alarm system to more than one Supra Touch, join the alarm relays in a continuous loop. The alarm relays must be in series with each other so any of the controls can trigger the alarm system when an alarm occurs.

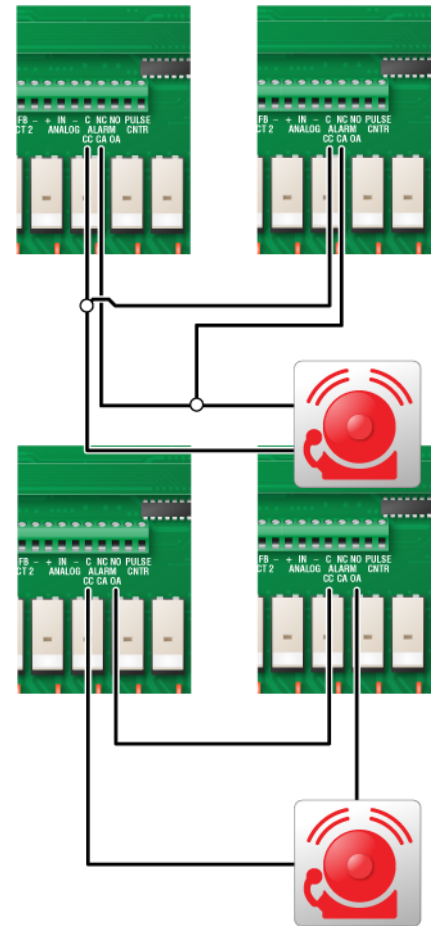

Connecting sensors

Supra Touch gives you the ability to monitor more than just zone temperatures. Connecting additional sensors gives you the ability to use modifiers that allow you to override settings when certain conditions are met, such as when carbon dioxide levels are too high. For more information, read **Programming modifiers** on page 41.

The following table shows the conditions you can monitor, the number of inputs, and the compatible sensors.

Condition	Inputs	Sensor
Zone temperature	4	Phason 3K Series
Outdoor temperature	1	Phason 3K Series
Humidity	1	Phason RHS or RHS-P
Wind speed	} 1	Phason WINDSPEED-03
Water flow / usage		Any water meter with a dry contact pulse output
Additional temperature and humidity	1	DOL 114
Carbon dioxide (CO ₂)	} 3	DOL 19
Ammonia (NH ₃)		DOL 53
Light		DOL 16

Follow these guidelines when connecting any type of sensor:

- ◆ Do not run the sensor cable in the same conduit as AC power cables
- ◆ Do not run the sensor cable beside AC power cables or near electrical equipment.
- ◆ When crossing other cables or power lines, cross them at a 90-degree angle.

3K Series temperature sensors

You can connect four Phason 3K Series temperatures sensors to any of the **TEMP1** to **TEMP4** terminals. These terminals are for zone control.

If you have sensors connected to more than one terminal and they are configured for the same zone, the control will average the temperatures to provide a more-balanced reading for the zone. For more information, read **Configuring sensor inputs** on page 28.

You can also connect a Phason 3K Series temperature sensor to the **OUTDOOR TEMP** terminal for monitoring outdoor temperatures.

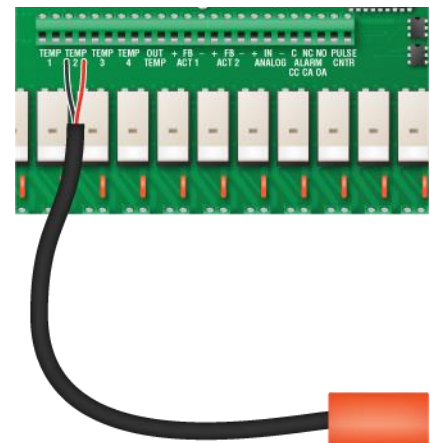

- ◆ If there are no functioning temperature sensors, Supra Touch controls the equipment as if the master set point for the zone is the actual temperature.
- ◆ Replace damaged temperature sensors as soon as possible. If a temperature sensor is damaged, disable it until you can replace it with a new one.
- ◆ When routing the temperature probe cables, do not run them in or along the same conduit as AC-power lines.



- ◆ You can extend probe cables up to 500 feet. For more information, read the **Control Fundamentals** guide that came with your control.

Relative Humidity Sensor

You can connect a Phason Relative Humidity Sensor (model RHS or RHS-P) to the **ANALOG** terminal.

1. Position the jumpers on the pins as shown.
2. Connect the wires from the humidity sensor as shown.

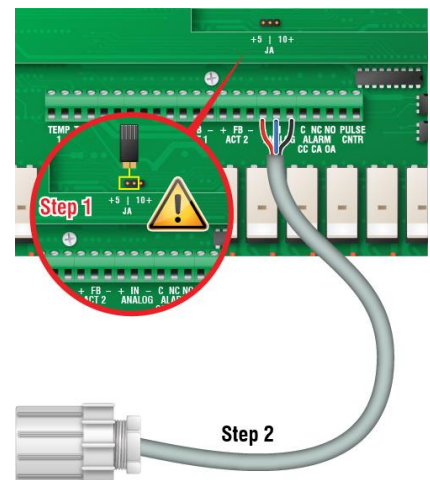

Wind speed sensor

You can connect a Phason Wind Speed Sensor (model WINDSPEED-03) to the **COUNT** terminal. Connect the wires from the wind speed sensor as shown.

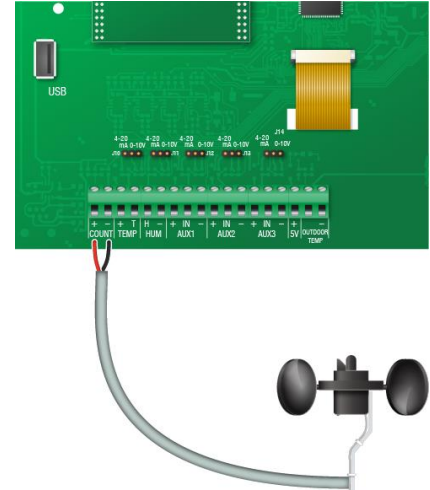

Water meter

You can connect a water meter to the **COUNT** terminal. The water meter must have a dry contact pulse output.

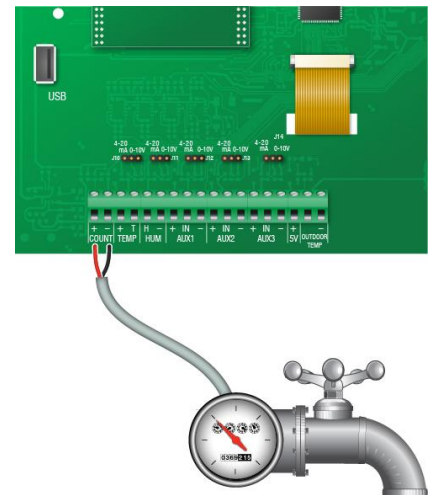

DOL 114 temperature and humidity sensors

You can connect a DOL 114 temperature and humidity sensor to the **TEMP/HUM** terminals as shown in the drawing.

1. Position the jumpers on the pins as shown.
2. Connect the wires from the DOL 114 sensor as shown.

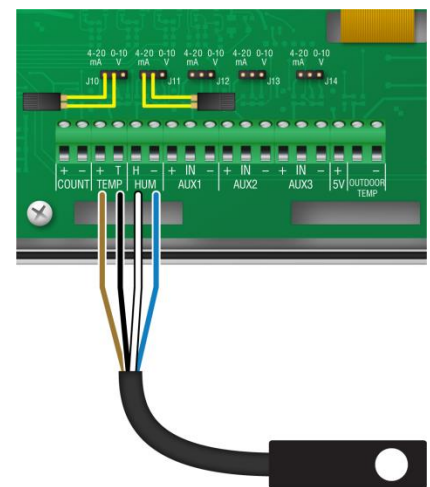

DOL 19 carbon dioxide sensors

You can connect a DOL 19 carbon dioxide sensor to the any of the three **AUX** terminals.



Set the output on the DOL19 sensor to 4 to 20 mA.
See the DOL19 installation guide for more information.

1. Position the jumper on the pins as shown.
2. Connect the wires from the DOL 19 sensor as shown.

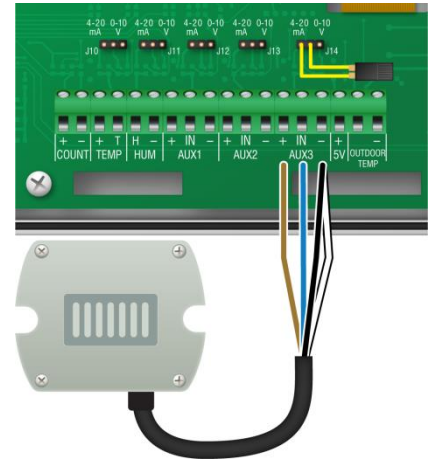

DOL 53 ammonia sensors

You can connect a DOL 53 ammonia sensor to the any of the three **AUX** terminals.

1. Position the jumper on the pins as shown.
2. Connect the wires from the DOL 53 sensor as shown.

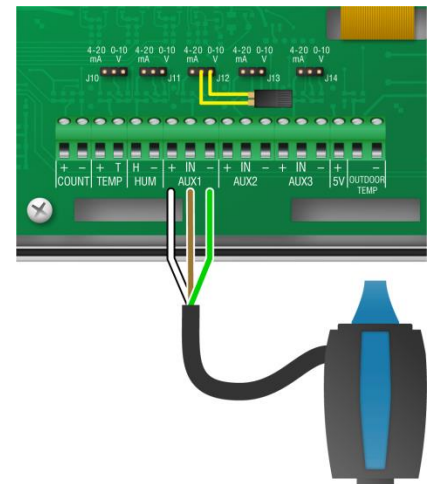

DOL 16 light sensors

You can connect a DOL 16 light sensor to the any of the three **AUX** terminals.

1. Position the jumper on the pins as shown.
2. Connect the wires from the DOL 53 sensor as shown.

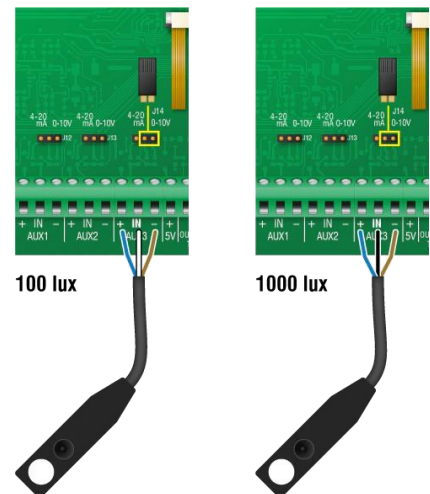

Connecting the power source

You can connect the Supra Touch to 120 or 230 VAC, 50 or 60 Hz power.



- ◇ Before connecting the incoming power, switch OFF the power at the source.
- ◇ Do not switch ON the power until you have finished all wiring and verified all equipment is properly connected and free of obstructions.



- ◇ Before connecting the power, set the voltage selection switch to the correct voltage.
- ◇ If you are using three-phase power, make sure the control power and the variable speed fans are connected to the same phase. For more information, read **Using three-phase power** on page 18.

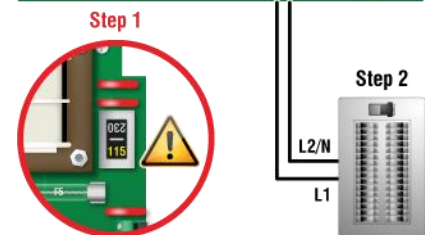
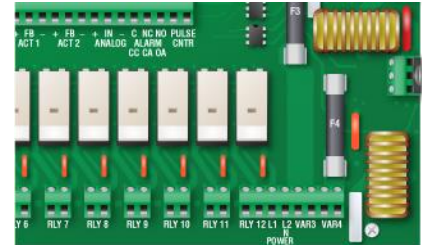

To connect the incoming power source

1. Set the voltage select switch to the correct voltage setting.
2. Connect the incoming power source as shown below.

Finishing the installation

If you filled in the Configuration worksheets starting on page 82, make sure they correspond to the way the equipment is connected to the Supra Touch. It is very important that the connections and the worksheets are the same; you want to be sure you are configuring the equipment you think you are controlling.

1. Make sure all the wires are properly connected to the correct terminals.
2. Make sure the voltage selection switch is in the correct setting, 115 or 230 VAC.
3. Make sure the display cable is properly connected. For more information, read **Bottom layout** on page 11.
4. Switch on the power to the control.
When you switch on the power to the Supra Touch, the display should show the status screen. If the display does not come on, go back to step 0. If the display shows an alarm message, read **Programming alarms** on page 43.
5. Close the cover and then tighten the four screws.



Do not over tighten the screws. Do not use power screwdrivers or drills.

Chapter 3: Configuring your Supra Touch

- ◆ **Configuring the main control functions** on page 25
- ◆ **Configuring equipment** on page 30

Configuring the Supra Touch includes “telling” it what equipment it will control and how it will control that equipment. For example, the Supra Touch has 12 relays; you need to the control if the equipment connected to the relays will control actuators, fans, heaters, or something else.

Before you begin configuring, make sure:

- ◆ The control has power.
- ◆ All equipment has been properly connected to the correct terminals.
- ◆ You know which equipment is connected to which terminals.



This chapter does not explain set points, idle speeds, or other settings. For information about those settings, **Chapter 4: Programming the Supra Touch** on page 33.

Configuration checklist

Because some items need to be configured before others, we recommend configuring the Supra Touch in following order.

Configuring main control functions

- Setting the clock
- Selecting the units of measure
- Configuring hysteresis
- Configuring relay stagger
- Configuring alarm silencing
- Configuring the zone control mode

Configuring variable stages and relays

- Configuring sensor inputs
- Configuring equipment (variable stages and relays)



- ◇ We recommend configuring **all** your equipment before programming the settings (temperature set points, idle speeds, and so on). Use the **Installation worksheets** on page 80 to help you keep track of which equipment is connected to which relays and variable stages.
- ◇ Supra Touch built-in tests are useful for testing your equipment after installing and configuring it. For more information, read **Testing sensors and equipment** on page 67.

Configuring the main control functions

Setting the clock

The Supra Touch has a clock that keeps track of the time for the daily high and low temperatures and the growth curves. If there is a power failure, or you need to adjust for daylight savings time, you will have to change the clock.



Supra Touch starts counting time as soon as it is connected to an incoming power supply.

To set the clock

1. Press the **Menu** and then **Configuration**.
2. Press **Date and Time**.
3. To switch between 12 and 24 formats, select or deselect **24-Hour Time**.
4. Press the **Up** or **Down** arrows to adjust the date and time.
5. Press **Save** when you are finished.

Selecting the units of measure

The Supra Touch displays temperatures in either degrees Fahrenheit (°F) or degrees Celsius (°C), but not both at the same time. The factory default is °F. If you want to change the temperature units, follow the steps below.

To select the units

1. Press **Menu** and then **Configuration**.
2. Press **Units**.
3. Select the units you want to use.
4. Press **Save** when you are finished.

Configuring hysteresis

Hysteresis helps prevent damage to the relays, variable stages, and the equipment connected to them by preventing the stages from switching on and off rapidly when the temperature is hovering close to the set point.

Hysteresis is the number of degrees above the set point that a heating stage or relay switches off, and the number of degrees below the set point that a cooling stage or relay switches off. For example, a household thermostat might switch on a furnace at 68°F when the house is cooling down, but switch it off at 70°F when the house is warming up. The difference between these two values is the hysteresis.

There are separate hysteresis values for each zone. All equipment assigned to the zone is affected by the zone's hysteresis value.

Default: 1.0°F (0.5°C) *Range:* 0.3 to 5.0°F (0.2 to 2.8°C)

To configure hysteresis

1. Press the **Menu** and then **Configuration**.
2. Press **Hysteresis**.
3. Press the **Up** or **Down** arrows to adjust the hysteresis value.
4. Press **Save** when you are finished.

Configuring relay stagger

Relay stagger prevents several relays from switching on at the same time by offsetting each relay when the control starts. Inlet relays are not affected by relay stagger.

Example

Let's say you have relays 1 and 2 configured for inlets; relays 3, 4, and 5 configured for cooling; and relay 6 configured for heating. The temperature is above the set point. This is what will happen when the control starts.

- ◆ Relays 1/2: not affected by relay stagger, switch on immediately
- ◆ Relay 3: switch on immediately
- ◆ Relay 4: switch on 5 seconds after relay 3
- ◆ Relay 5: switch on 5 seconds after relay 4
- ◆ Relay 6: remain off

Default: 5 seconds *Range:* 0 to 59 seconds

To configure relay stagger

1. Press the **Menu** and then **Configuration**.
2. Press **Relay Stagger**.
3. Press the **Up** or **Down** arrows to change stagger duration.
4. Press **Save** when you are finished.

Configuring alarm silencing

Alarm silencing is the amount of time an alarm is temporarily disabled (silenced) after it has been acknowledged. Alarm silencing prevents the alarm relay from triggering immediately if it has been acknowledged when the alarm condition is still present. If the alarm condition is still present after the silencing duration, the alarm triggers again.

Default: 15 minutes

Range: 1 to 240 minutes (4 hours)

To configure alarm silencing

1. Press the **Menu** and then **Configuration**.
2. Press **Alarm Silencing**.
3. Press the **Up** or **Down** arrows to change the alarm silencing variation.
4. Press **Save** when you are finished.

Configuring the zone control mode

There are two zone control modes: staged and merged.

Staged mode

Staged mode is the traditional ventilation mode that uses “stages” of variable and/or fixed stage equipment. As the temperature increases, stages increase speed or switch on in sequence to increase ventilation and cool the room.

Staged mode uses a master set point and individual equipment set points. A master set point is the desired or target temperature for a zone. When you adjust the master set point, the equipment set points are automatically adjusted by the same amount.

You can use a growth curve and/or a minimum ventilation curve in staged mode.

Merged mode

Merged mode uses steps. Each step has a temperature range and an output range for the equipment that operates during the step. As the temperature increases, ventilation equipment increases speed, switches on, or opens to increase ventilation and cool the room. One of the benefits of merged mode is that it can provide smoother transitions between steps than staged mode can between stages.

Merged mode can have up to 10 steps. Each step has a temperature range and an output range for the equipment that operates during the step.



You can use a growth curve in merged mode, but you cannot use a minimum ventilation curve.



- ◇ For information about growth curves, read **Programming growth curve** on page 37.
- ◇ From information about minimum ventilation curves, read **Programming minimum ventilation curve** on page 39.

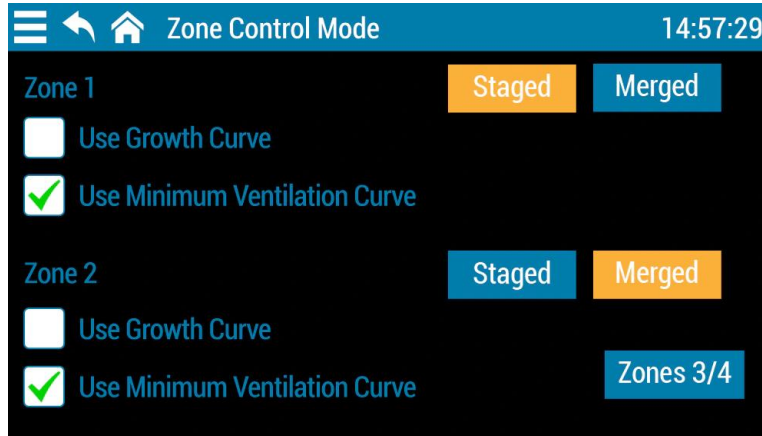

To configure zone control

1. Press the **Menu** and then **Configuration**.
2. Press **Zone Control Mode**.
3. For each zone you are configuring, choose **Staged** or **Merged** ventilation.
4. If you will be using a growth curve and/or minimum ventilation curve (staged only), press the checkbox beside that option.
5. Press **Save** when you are finished.

Configuring sensor inputs

Supra Touch supports the following sensors connected to the specified inputs. Others are not supported.

Input	Location	Sensor types	Zone control	Influencer
TEMP1 to 4	Bottom	Phason 3K Series	YES	YES
TEMP HUM	Cover	DOL 114 Temperature and Humidity Sensor	TEMP – YES HUM – NO	YES
AUX1 AUX2 AUX2	Cover	DOL 19 Carbon Dioxide (CO2) DOL 53 Ammonia Sensor (NH3) DOL 16 Light Sensor	NO	YES
OUT TEMP	Bottom	Phason 3K Series	NO	YES
COUNT	Cover	Phason Wind Speed Sensor, water meter	NO	YES

For the exact location of the sensor inputs, see the diagrams on pages 11 and 12.

Temperature averaging and zone control

If you have more than one temperature sensor assigned to control a zone, Supra Touch automatically averages the temperature readings it receives. Temperature averaging provides a more balanced, overall temperature for a zone.



- ◇ If there are no functioning temperature sensors, Supra Touch controls the equipment as if the master set point for the zone is the actual temperature.
- ◇ Replace damaged temperature sensors as soon as possible. If a temperature sensor is damaged, disable it until you can replace it with a new one.

Influencers / modifiers

Influencers, also called modifiers, are sensors that can modify zone control. For example, you can use a humidity sensor to modify ventilation and increase ventilation when humidity levels are too high. For more information, read **Programming modifiers** on page 41.

To configure inputs

1. Press the **Menu** and then **Configuration**.
2. Press **Sensors**.
3. Press the type of input you want to configure.
4. Press the input you want to configure.
The Sensor Configuration screen displays.

- ◆ **Name:**
 - a) Press the button beside Name and then press **Rename**.
 - b) Press **Reset** and then type the new name.
 - c) When finished, press **Confirm** to save the name and return to the previous screen.

- ◆ **Function:**
Press the button beside Function. If there only one option available, it will be enabled. If there is more than one option available, select the one you want from the list.

- ◆ **Control zones:**
Sensors connected to inputs TEMP 1-4 on the bottom board or TEMP on the display board can be used to control zones. Other inputs will not display this option. Select each zone the sensor will control.

- ◆ **Influence zones:**
All sensors can be used to influence control zones. If the sensor will influence zones, select the zones.

5. Press **Save** when you are finished.

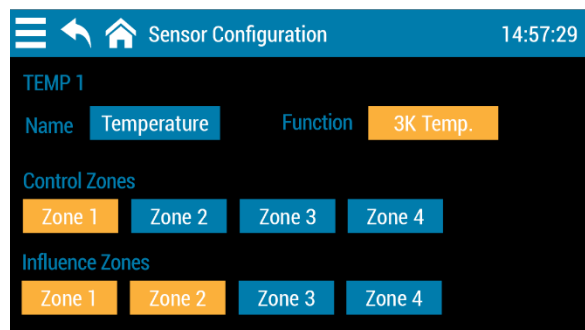
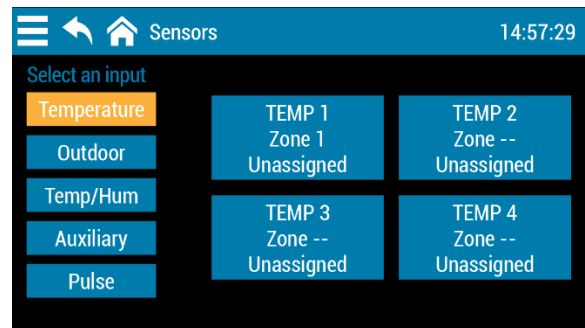

Configuring equipment

Configuring variable stages

The Supra Touch has four variable AC stages (**VAR 1** to **VAC 4**) to control equipment using gradually increasing or decreasing voltage. Variable stages can be cooling or heating.

- ◆ **Cooling:** the stage controls cooling equipment, such as a variable speed fan.
- ◆ **Heating:** the stage controls heating equipment, such as a heat lamp.

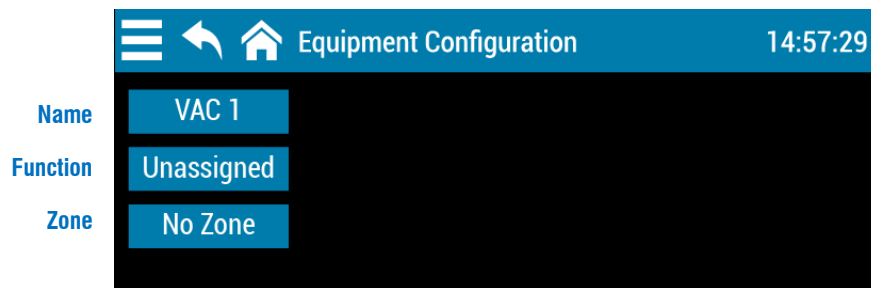

To configure variable stages

1. Press the **Menu** and then **Configuration**.
2. Press **Equipment**.
3. Press **VACs**.
4. Press the variable stage you want to configure.
The Equipment Configuration screen displays.
 - ◆ **Name:**
 - a) Press the button beside Name and then press **Rename**.
 - b) Press **Reset** and then type the new name.
 - c) When finished, press **Confirm** to save the name and return to the previous screen.
 - ◆ **Function:**
Press the button beside Function and then choose the equipment type. If you choose cooling, motor curve and de-icing options become available.
 - ◆ **Motor curve:**
The default is motor curve 1. Change the motor curve *only if you need to*. Read **Motor curves** on page 92 before changing the motor curve.
To change the curve, press the button and then select one of the other ones.
 - ◆ **De-icing:**
To enable de-icing, press the checkbox beside it. Press the Up or Down arrows to adjust the setting.
 - ◆ **Zone:**
Press the button beside Zone and then choose the one the equipment will operate in.
5. Press **Save** when you are finished.

Configuring relays

Supra Touch has 12 relays that can be configured for any of the following functions:

- ◆ **Unassigned:** the relay is always open/off. This is the default.
- ◆ **Cooling:** the relay controls cooling equipment, such as a fan, and switches on when temperatures are above the set point.
- ◆ **Cooling duty cycle:** the relay controls cooling equipment and switches on and then off for specified durations when temperatures are above the set point.
- ◆ **Heating:** the relay controls heating equipment, such as an electric heater, and switches on when temperatures are below the set point.
- ◆ **Heating duty cycle:** the relay controls heating equipment and switches on and then off for specified durations when temperatures are below the set point.
- ◆ **Follow relay / variable:** the relay controls equipment that is on when a selected relay or variable stage is on.



To configure relays

1. Press the **Menu** and then **Configuration**.
2. Press **Equipment**.
3. Press **Relays**.
4. Press the relay you want to configure.
The Equipment Configuration screen displays.
 - ◆ **Name:**
 - a) Press the button beside Name and then press **Rename**.
 - b) Press **Reset** and then type the new name.
 - c) When finished, press **Confirm** to save the name and return to the previous screen.
 - ◆ **Function:**
Press the button beside Function and then choose the equipment type. If you choose “relay follower” or “variable follower”, you will need to press **Following** and then choose the output that the relay will follow.
 - ◆ **Zone:**
Press the button beside Zone and then choose the one the equipment will operate in.
5. Press **Save** when you are finished.

Configuring relays for inlet actuators or curtains

Inlets, curtains, and similar equipment are opened and closed to let in more air or less air. The idea is that more air cools the building. There are two types of inlets: inlets with feedback and inlets without feedback. Each requires one relay for opening and one for closing.

Inlets with feedback

The relays control a motor that opens and closes and requires feedback to know its position. An example is an actuator. You can configure up to two inlets that require feedback.

Inlets without feedback

The relays control a motor that opens and closes, but does not require feedback. An example is a curtain machine or winch. You can configure up to six inlets that do not require feedback.



Use the **Relay configuration worksheet** on page 84 when configuring relays.

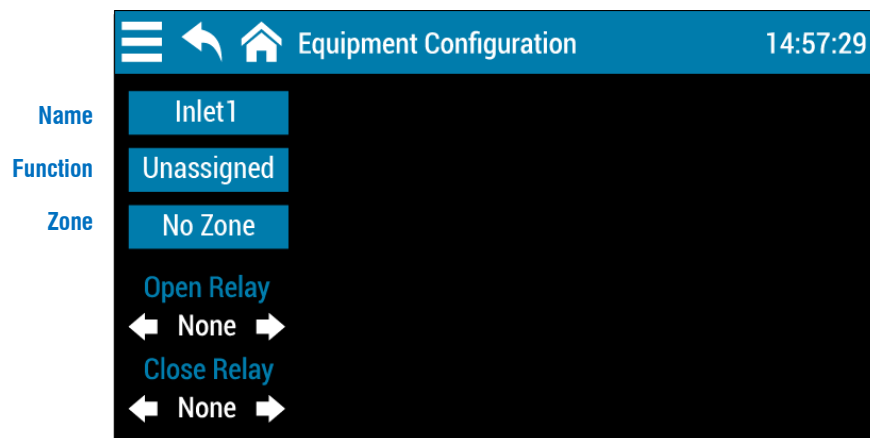

To configure relays for inlets

1. Press the **Menu** and then **Configuration**.
2. Press **Equipment**.
3. Press **Inlets**.
4. Press the inlet you want to configure.
The Equipment Configuration screen displays.

◆ **Name:**

- a) Press the button beside Name and then press **Rename**.
- b) Press **Reset** and then type the new name.
- c) When finished, press **Confirm** to save the name and return to the previous screen.

- ◆ **Function:**
Press the button beside Function and then choose the equipment type. If you choose “with feedback”, the **Calibrate Actuator** button will display. For more information, read **Calibrating inlet actuators** below. Such
- ◆ **Zone:**
Press the button beside Zone and then choose the one the equipment will operate in.
- ◆ **Relays:**
Press the **Left** or **Right** arrows below Open Relay and Close Relay to choose a relay for each.

5. Press **Save** when you are finished.

Calibrating inlet actuators

After you configure relays for inlet actuators, you need to calibrate the actuators. Calibrating the actuator lets the control know the position of the actuator when it is fully extended and fully retracted. Supra Touch uses the limits to define the range of motion it uses to position the inlets. The limits tell the control how much to adjust when you want the inlets open 25 percent, for example.

During calibration, the actuator opens, pauses, and then closes. If the actuator is operating properly, the inlet should open completely and then close completely. After closing completely, the actuators should position according to the temperature and default settings.



- ◇ Before calibrating actuators, make sure the limit switches are set and the cable and counter weights can move freely.
- ◇ If calibration stops after closing the first time or fails to position properly, the feedback signal is not connected correctly. Verify the potentiometer wiring. For more information, read **Determining correct actuator feedback wiring** on page 78.
- ◇ Because cables can stretch and equipment can come out of alignment, we recommend you reset the limit switches and calibrate your actuators at least once each year.

To calibrate inlet actuators

1. At the Status screen, press the widget for the actuator you want to calibrate.
2. Press **Calibrate**.
3. Press **Yes** to start calibration or **No** to cancel.
If you started calibration, the actuator should open all the way and then close all the way. If calibration is successful, the actuator will move into position according to its settings.

Configuring relays for air curtains

Air curtains use relays to switch blowers on to inflate and off to deflate air bags. An air curtain can have from two to six air bags. Each air bag requires a separate relay.



The open order is always 1-2-3-4-5-6 and the close order is always 6-5-4-3-2-1.



Use the **Relay configuration worksheet** on page 84 when configuring relays.

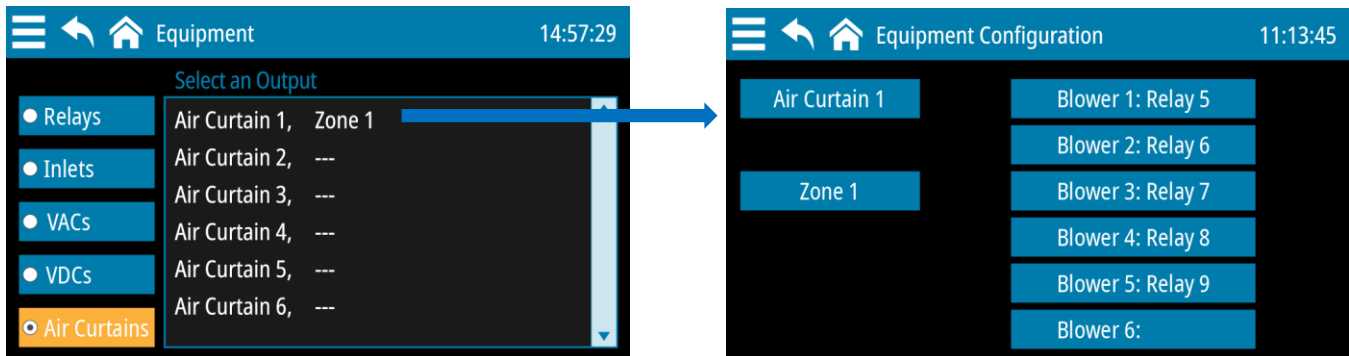

To configure relays for air curtains

1. Press the **Menu** and then **Configuration**.
2. Press **Equipment**.
3. Press **Air Curtains**.
4. Press the air curtain you want to configure.
The Equipment Configuration screen displays.
5. Press the button beside Zone and then choose the zone the equipment will operate in.
6. Press the first Blower button and then select the relay that will control it. Repeat this step for each blower in the air curtain.
7. Press **Save** when you are finished.

Chapter 4: Programming the Supra Touch

- ◆ **Programming zone settings** on page 36
- ◆ **Programming equipment settings** on page 45

Before you program the Supra Touch

Programming your Supra Touch means “telling” the equipment what you want it to do and when you want it done. For example, for a single-speed fan set for cooling, you might say “Switch on when the temperature reaches 80°F.”

Programming checklist

Because some settings must be programmed before others, we recommend you program the Supra Touch in the following order. If you do not have equipment of a particular type, for example, curtains, skip that step.

Programming zone settings

- Programming the master set point
- Programming growth curve
- Programming minimum ventilation curves
- Programming modifiers
- Programming alarms

Programming equipment settings

- | | |
|---|--|
| <p>Staged ventilation <i>OR</i></p> <ul style="list-style-type: none"><input type="checkbox"/> Programming variable cooling stages<input type="checkbox"/> Programming inlet actuators<input type="checkbox"/> Programming curtain control relays<input type="checkbox"/> Programming relay stages<input type="checkbox"/> Programming duty cycles <p>Heating</p> <ul style="list-style-type: none"><input type="checkbox"/> Programming variable heating stages<input type="checkbox"/> Programming duty cycles | <p>Merged ventilation</p> <ul style="list-style-type: none"><input type="checkbox"/> Programming merged ventilation |
|---|--|

Before you program the Supra Touch, make sure:

- ◆ It has power
- ◆ All equipment has been properly connected to the correct terminals
- ◆ You know which equipment is connected to variable stages, relays, and sensor inputs
- ◆ All variable and relay stages have been properly configured and tested
For more information, read **Chapter 3: Configuring your Supra Touch** on page 24.



Use **Settings worksheets** on page 85 when programming the Supra Touch.

Programming zone settings

- ◆ Master set point (below)
- ◆ Growth curves (on page 37)
- ◆ Minimum ventilation curves (on page 39)
- ◆ Modifiers (on page 41)
- ◆ Alarms (on page 43)

Programming the master set point

A master set point is the target or desired temperature for the zone. This is the temperature that will be tracked by the individual stages. The individual set points for each variable and relay stage will be adjusted relative to the master set point for that zone. **Make sure you set the master set point before setting the individual set points.**

For example, say the master set point for zone 1 is 80°F, a variable-stage fan set point is 5 degrees higher (85°F), and a single-stage heater set point is 7 degrees lower (73°F). If you lower the master set point to by 5 degrees to 75°F, the set points for the fan and heater will also be lowered by 5 degrees: to 80°F and 68°F.



If you do not want the individual (equipment) set points to change when you adjust the master set point, then select *Maintain other set points*.

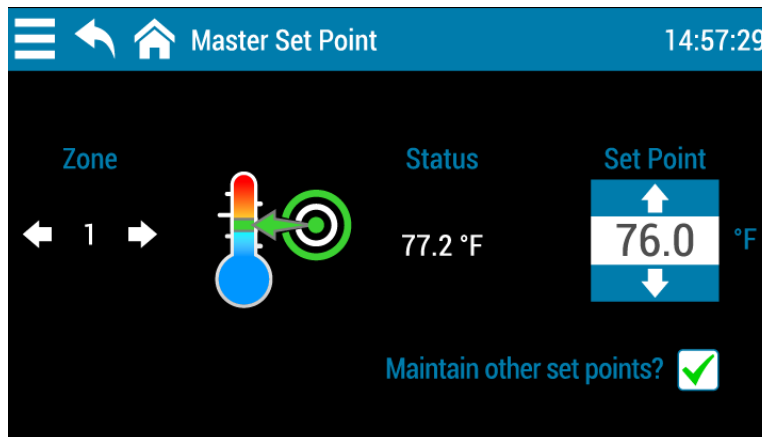

To program the master set point

1. Press the **Menu** and then **Settings**.
2. Press **Master Set Point**.
3. If you *do not* want the individual (equipment) set points to change when you adjust the master set point, select **Maintain other set points**.
4. Below *Zone*, press the **Left** or **Right** arrows to choose the zone.
5. Below *Set Point*, press the **Up** or **Down** arrows to set the master set point for the zone.
6. Press **Save** when you are finished.



You can also get the master set point from the status screen.

Programming growth curves

A growth curve is an extension of the master set point concept. The growth curve automatically adjusts the temperature set points over time to control the temperature. For example, in hog production, newborn piglets require a high temperature for comfort and health. As they grow older, they need a steadily lower temperature. Using the growth curve, Supra Touch automatically adjusts the temperatures.

You can have up to seven steps in a growth curve. Each step has a start date and temperature. Supra Touch automatically calculates the set points for the days between the steps and adjusts the set points at midnight each day. Individual set points for the variable and fixed stages are adjusted relative to the growth curve temperature. Growth curves are an extremely powerful feature because they help you put fan and heating strategies in place once, and then adjust them automatically over time.

For example, in the following table, the duration of step 2 is 10 days. The difference between the starting set point (86.5°F) and the starting set point for the next step (85°F) is 1.5°F. Supra Touch divides the temperature difference by the duration, $1.5 \div 10 = 0.15$, and then automatically adjusts the set point by 0.15°F each day for 10 days.

Step	Temperature (°F)	Duration (days)
1	88.0	5
2	86.5	10
3	85.0	10
4	83.5	10
5	81.0	5
6	78.0	5
7	74.0	10

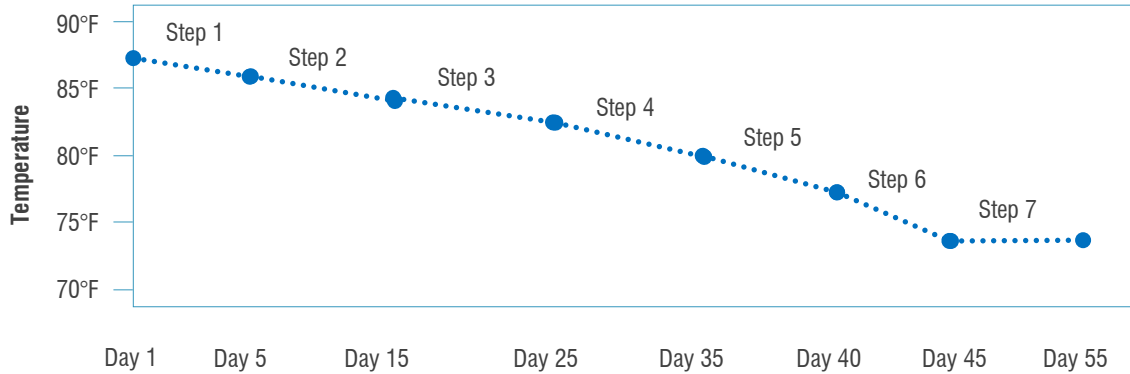

Use the **Growth curve worksheet** on page 85 when programming growth curves.



- ◇ If you have a growth curve controlling the zone, you cannot adjust the master set point.
- ◇ The growth curve resets at the **beginning** of the restart day.

☰ ← 🏠 Growth Curve - Zone 1 14:57:29

Step Start Day							Zone
↑	↑	↑	↑	↑	↑	↑	← 1 →
1	5	15	25	40	60	90	Current Day
↓	↓	↓	↓	↓	↓	↓	← 100 →
Temperature (°F)							Restart Day
↑	↑	↑	↑	↑	↑	↑	↑
20	25	30	35	40	45	50	110
↓	↓	↓	↓	↓	↓	↓	↓

To program growth curves

1. Press the **Menu** and then **Settings**.
2. Press **Staged Ventilation**.
3. Press **Ventilation Curve**.
4. Below *Zone*, press the **Left** or **Right** arrow to choose the zone.
5. Below *Step Start Day*, press the **Up** or **Down** arrows to set the start day for each step.
6. Below *Restart Day*, press the **Left** or **Right** arrow to choose the zone.
7. Below *Temperature*, press the **Up** or **Down** arrows to set the master set point for the start day of each step.
8. Press **Save** when you are finished.

To change the current day

1. Press the **Menu** and then **Settings**.
2. Press **Staged Ventilation**.
3. Press **Ventilation Curve**.
4. Below *Current Day*, press the **Left** or **Right** arrow to change the day.
5. Press **Save** when you are finished.

Programming minimum ventilation curves

Minimum ventilation is very important for controlling humidity and getting rid of gases such as carbon dioxide and ammonia. Insufficient ventilation can cause high humidity, high gas levels, and stagnant air. As animals grow older, they require more fresh air but produce more humidity and gases. Using a minimum ventilation curve, you can have Supra Touch automatically adjust the minimum ventilation as the animals grow.



- ◇ The minimum ventilation curve affects only the first variable stage that is configured as cooling for the zone.
- ◇ If you are using a minimum ventilation curve you cannot adjust the idle speed in the variable stage settings.

How ventilation curves work

Supra Touch reads the curve each day at midnight changes the idle speed setting for the current day. At the end of the curve, the control continues using the settings from the last day of the curve.

The minimum ventilation curve affects only the first variable stage that is configured as cooling for the zone. The following examples show which variable stage would be affected by the minimum ventilation curve in different situations.

Example 1

VAR 1 - Cool	Controlled by curve
VAR 2 - Cool	Not controlled

Example 2

VAR 1 - Heat	Not controlled
VAR 2 - Cool	Controlled by curve

Example 3

VAR 1 - Unused	Not controlled
VAR 2 - Unused	Not controlled
VDC 1 - Unused	Not controlled
VDC 2 - Cool	Controlled by curve
VDC 3 - Heat	Not controlled
VDC 4 - Unused	Not controlled

Curve length and current day

Curve length is the number of days in the curve. Curves can have up to 365 days. Current day defines which day's settings Supra Touch is using.

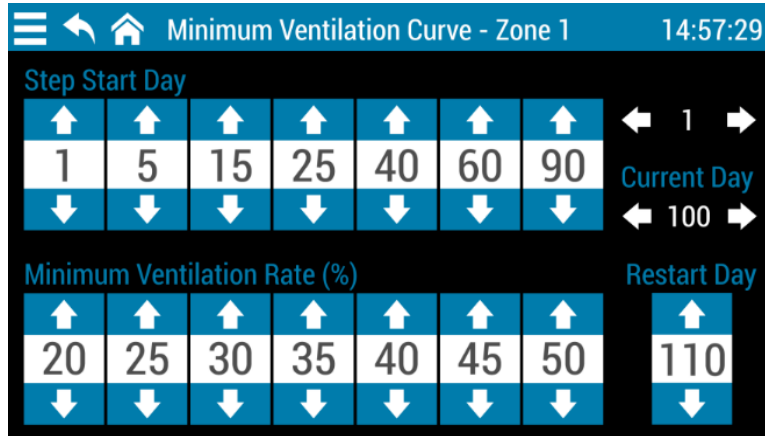

To program minimum ventilation curves

1. Press the **Menu** and then **Settings**.
2. Press **Staged Ventilation**.
3. Press **Ventilation Curve**.
4. Below *Zone*, press the **Left** or **Right** arrow to choose the zone.
5. Below *Step Start Day*, press the **Up** or **Down** arrows to set the start day for each step.
6. Below *Restart Day*, press the **Left** or **Right** arrow to choose the zone.
7. Below *Minimum Ventilation Rate*, press the **Up** or **Down** arrows to set the idle speed for the start day of each step.
8. Press **Save** when you are finished.



Before you can set the current day, you must configure the zone to use the minimum ventilation curve. For more information, read **Configuring the zone control mode** on page 27.

To change the current day

1. Press the **Menu** and then **Settings**.
2. Press **Staged Ventilation**.
3. Press **Ventilation Curve**.
4. Below *Current Day*, press the **Left** or **Right** arrow to change the day.
5. Press **Save** when you are finished.

Programming modifiers

Modifiers, sometimes called influencers, allow you to override equipment settings when certain conditions are met, regardless of temperature. You can have up to three modifiers for each variable stage or relay.

Type and sensor

Type can be either a zone reading or sensor reading. Zone reading is the average temperature of all temperature sensors configured for the zone. If you have other sensors configured as modifiers for the zone, for example CO₂ (carbon dioxide) or NH₃ (ammonia), you can choose one of those types.

If you select a type of sensor and there is more than one sensor of that type, you need to select the specific sensor you want to use.



You must have a sensor configured to modify equipment settings in the zone before you can select it as a modifying sensor. For more information, read **Configuring sensor inputs** on page 28.

Modifier modes

Set value modifiers set a variable stage or relay to a specific value or state when a condition is met. For example, “When the humidity is over 90%, switch on a fan.”

Influence modifiers (variable only) adjust the output of a variable stage proportionally over a range of values. The adjustment can be an increase or decrease.

For example, let's say a CO₂ modifier starts at 2500 ppm and ends at 3500 ppm; the starting adjustment is +10 and ending is +40. When the CO₂ is 2500, the modifier increases the output by 10%. As the CO₂ rises, the modifier increases in the output proportionally until the CO₂ is 3500 ppm and the output +40%.

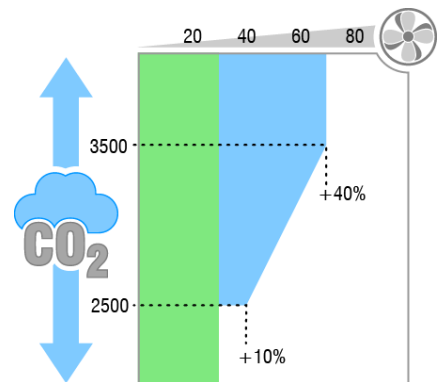

And With Next modifiers must meet two conditions before setting or adjusting the output. For example, “When the temperature is over 80°F and the humidity is over 90%, switch on a fan.”

To view modifiers

- ◆ Press the left or right arrow beside *Output* to view or choose which variable stage or relay you want to modify.
- ◆ If you have two or three modifiers for an output, press the left or right arrow beside *Modifier* to view them.

To program “set value” or “and with next” modifiers

1. Press the **Menu** and then **Settings**.
2. Press **Modifiers**.
3. Press the **Left** or **Right** arrows beside *Output* and *Modifier* to choose the output and modifier.
4. Press the button beside *Mode* and then select *Set Value*.
5. Press the button beside *Type* and then select one of the sensor types. If you have more than one of the above types of sensors, press the button beside *Sensor* and then select the specific sensor.
6. Press the **<** or **>** below *Comparison* to choose whether you want to modify when the sensor reading is less than or greater than the value.
7. Press the **Up** or **Down** arrows below *Value* to set the value to which the sensor reading will be compared.
8. If you are programming a “set value” modifier, press the **Up** or **Down** arrows beside *Set Output* to set the output the stage or relay will be at while modified.
9. Press **Save** when you are finished.

To program “influence” modifiers

Influence modifiers are for variable stages only.

1. Press the **Menu** and then **Settings**.
2. Press **Modifiers**.
3. Press the **Left** or **Right** arrows beside *Output* and *Modifier* to choose the output and modifier you want to program.
4. Press the button beside *Mode* and then select *Set Value*.
5. Press the button beside *Type* and then select one of the sensor types. If you have more than one of the above types of sensors, beside *Sensor*, press the button and then select the specific sensor.
6. Press the **Up** or **Down** arrows below *Start At* and *End At* to set the range of values within which the stage or relay will be modified.
7. Press the **Up** or **Down** arrows below *Starting Output* to set the output at the beginning of the influence range, and *Ending Output* to set the output at the end of the influence range.
8. Press **Save** when you are finished.

To remove modifiers

1. Press the **Menu** and then **Settings**.
2. Press **Modifiers**.
3. Press the **Left** or **Right** arrows beside *Output* and *Modifier* to choose the output and modifier you want to remove.
4. Press **Clear Modifier**.
5. Press **Save** when you are finished.

Programming alarms

An alarm occurs if an enabled alarm condition is present for longer than the minimum duration of one minute. The one-minute minimum duration prevents alarms from occurring when the temperature rises or drops for just a few seconds. The exception to the one minute minimum is actuator jam alarms. Actuator jam alarms activate 20 seconds after the alarm is detected.

When an alarm occurs, the alarm relay triggers (switches) and a message flashes on the screen. For more information, read **Acknowledging alarms** on page 66.

The actuator jam alarm has no settings, which you can enable or disable it. Temperature alarms are described below.

Temperature alarms

If the high temperature alarm setting is 85.0°F and the temperature rises to 86 degrees, but drops below 85 degrees 30 seconds later (before the minimum duration of 1 minute), there is no alarm.

If the temperature rises to 86 degrees and stays there for 1 minute, an alarm occurs. The alarm relay remains active until the temperature drops below the high temperature alarm setting.

Outdoor temperature compensation

The purpose of outdoor temperature compensation is to prevent high temperature alarms from occurring on hot days when the temperature set point cannot be maintained. Outdoor temperature compensation is available for zones only, not individual sensors, and requires a temperature sensor that is mounted outdoors.

Outdoor compensation is the offset added to the high temperature alarm setting when the outdoor temperature is higher than the high alarm setting. High maximum is the highest temperature you can have in the zone; any temperature above this value is an alarm condition.

You set the compensation offset and the high maximum values. Supra Touch adds the compensation offset to the outdoor temperature to create a new setting called the *compensated high alarm*. The compensated high alarm becomes the new temperature limit, up until the high alarm maximum. When the zone temperature is higher than the compensated high alarm, there is an alarm condition.

In the example below, the high alarm is 75°F, compensation offset is 5°F, and high maximum is 85°F. Supra Touch adds 5° to the outdoor temperature to create the compensated high alarm, up to a maximum of 85°F.

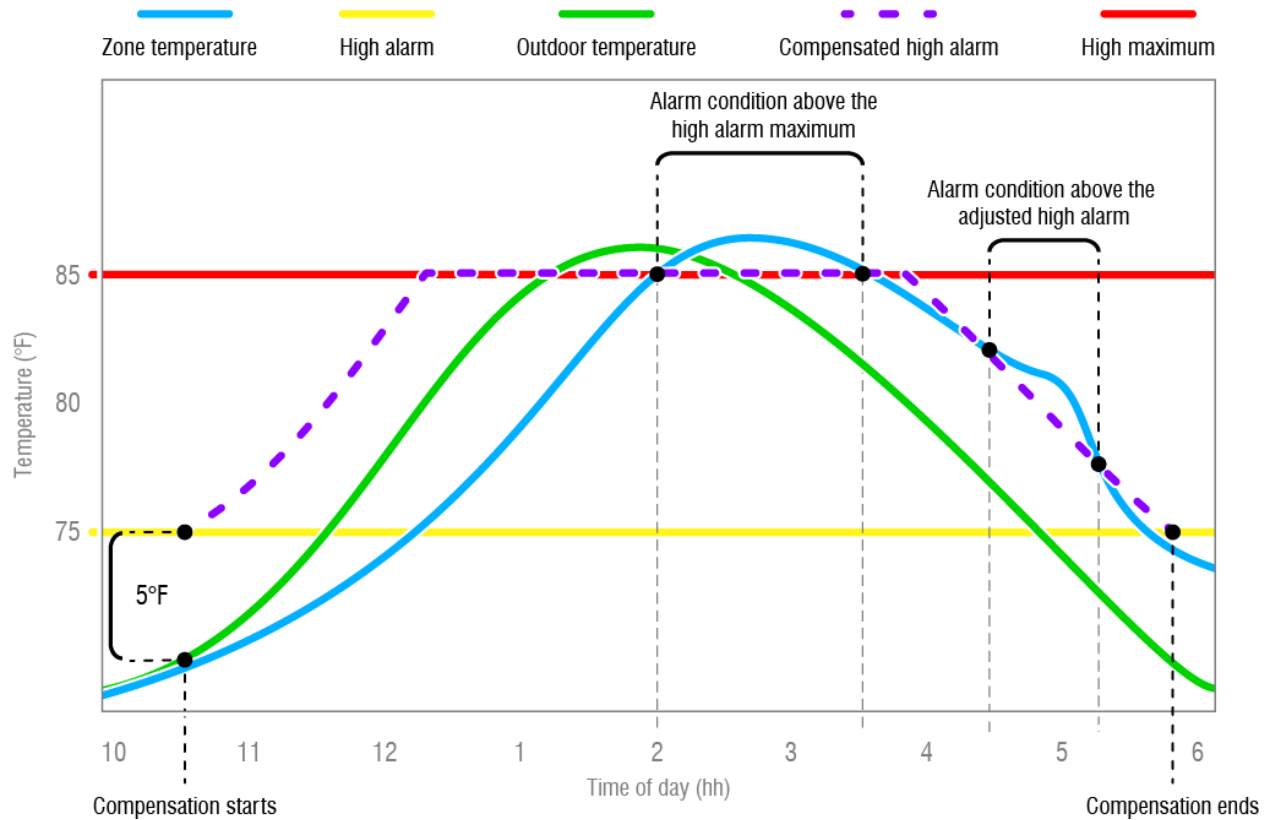

- ◆ At 10:30 AM, temperature compensation starts because the outdoor temperature plus the compensation offset is higher than the high temperature alarm setting.
- ◆ At 2:00 PM, there is an alarm condition because the zone temperature exceeds the high alarm maximum.
- ◆ 4:30 PM, there is an alarm condition because the room temperature exceeds the compensated high alarm.
- ◆ 5:45 PM, compensation ends because the outdoor temperature plus the compensation offset is less than the high temperature alarm setting.



Use the **Alarm settings worksheet** on page 91 when programming alarms. The worksheet contains descriptions of each setting.

☰ 🏠 Alarms 14:57:29

Zone	High Alarm	Compensation Offset
← 1 →	Enable <input checked="" type="checkbox"/>	Enable <input checked="" type="checkbox"/>
	↑ 90.0 °F ↓	↑ 5.0 °F ↓
	Low Alarm	High Maximum
Status	Enable <input checked="" type="checkbox"/>	
No Alarm	↑ 60.0 °F ↓	↑ 98.0 °F ↓

To enable or disable alarms

1. Press the **Menu** and then **Settings**.
2. Press **Alarms**.
3. Below *Zone*, press the **Left** or **Right** arrow to choose the zone, sensor, or equipment you want.
4. To enable or disable an alarm, press the **Enable** box beside the one you want to enable. There is a check in the box when enabled
5. Press **Save** when you are finished.

To program zone alarms

1. Press the **Menu** and then **Settings**.
2. Press **Alarms**.
3. Below *Zone*, press the **Left** or **Right** arrow to choose the zone, sensor, or equipment you want.
4. Press the **Up** or **Down** arrows to adjust the set points (except for actuator jam alarms).
5. To enable or disable an alarm, press the **Enable** box beside the one you want to enable. There is a check in the box when enabled
6. Press **Save** when you are finished.

Programming equipment settings

Programming the stages means entering the settings such as set points, idle speeds, ON/OFF times and durations, and so on.

Staged ventilation

- ◆ Variable stages (on page 47)
- ◆ Relays
 - ◆ Actuators (on page 50)
 - ◆ Curtains (on page 52)
 - ◆ Relay stages (on page 60)
 - ◆ Duty cycles (on page 61)

Merged ventilation

- ◆ Merged (below)

Heating

- ◆ Variable stages (on page 48)
- ◆ Relay stages (on page 61)
- ◆ Duty cycles (on page 62)

Programming merged ventilation

Merged mode uses up to 10 steps. Each step has a temperature range for the equipment that operates during the step. Each type of ventilation equipment has its own settings for each step. One of the benefits of merged mode is that it can provide smoother transitions between steps than staged mode can between stages.

The following example shows for step and includes two variable stages, one fixed stage, and inlets.

	Steps		Variables				Fixed	Inlets	
	Set points		VAR 24in		VAR 36in		F18	Actuator	
	Start Temperature	End Temperature	Start Output	End Output	Start Output	End Output	State	Start Position	End Position
1	68	72	30	80	0	0	OFF	25	40
2	72	75	50	100	20	50	OFF	40	60
3	75	80	100	100	0	50	ON	60	80
4	80	85	100	100	50	100	ON	80	100

Each step's start and end temperatures define the range of the step. The equipment columns (variables, fixed, and inlets) show the settings during the step.

As the temperature rises or falls within a step, the speed of variables and position of inlets will increase or decrease proportionally; fixed stages will be at their assigned state. When the temperature rises above or falls below the range for a step, Supra Touch uses the next step. In the example above, when the temperature is 74.5°F, Supra Touch uses step 2. When the temperature rises over 75°F, the control uses step 3.

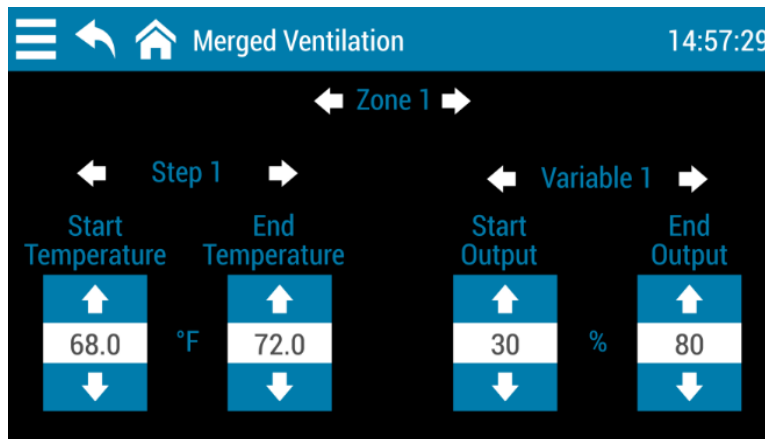

- ◇ You must have the zone configured for merged ventilation to program it.
- ◇ You can use a growth curve in merged mode, but you cannot use a minimum ventilation curve.
- ◇ Program the master set point or growth curve before you program merged ventilation.
- ◇ The set points for merged ventilation cannot be lower than the master set point or growth curve (if configured to use growth curve).



Programming variable cooling stages

Before programming the variable stages, make sure you have properly configured them. For more information, read **Configuring variable stages** on page 30.

How variable stage cooling works

- ◆ When the temperature is below the **idle range** temperature, the fan is off.
- ◆ When the temperature reaches the **idle range** temperature, the fan runs at the **idle speed**. The fan continues to run at the **idle speed** until the temperature rises to the **set point** temperature.
- ◆ When the temperature is between the **set point** and **on differential** temperatures, fan speed increases or decreases proportionally with the temperature.
- ◆ When the temperature is at or above the **differential** temperature, the fan runs at full speed.

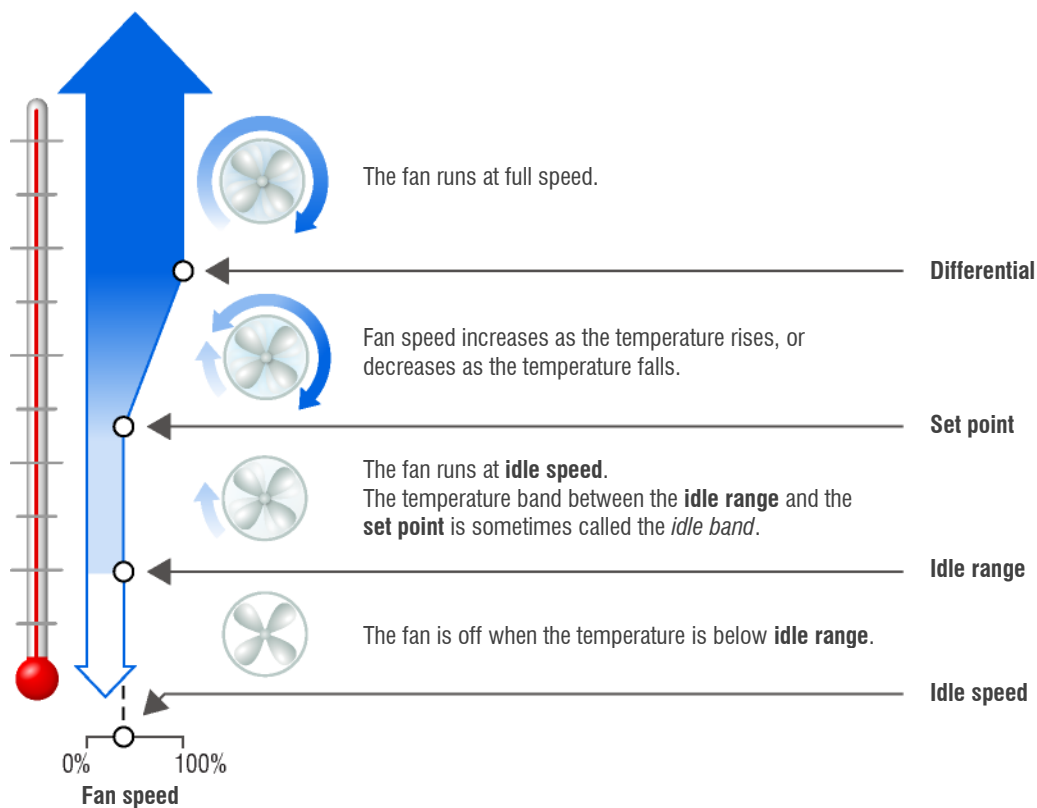

Use the **Variable stage settings worksheet** on page 86 when programming variable stages.

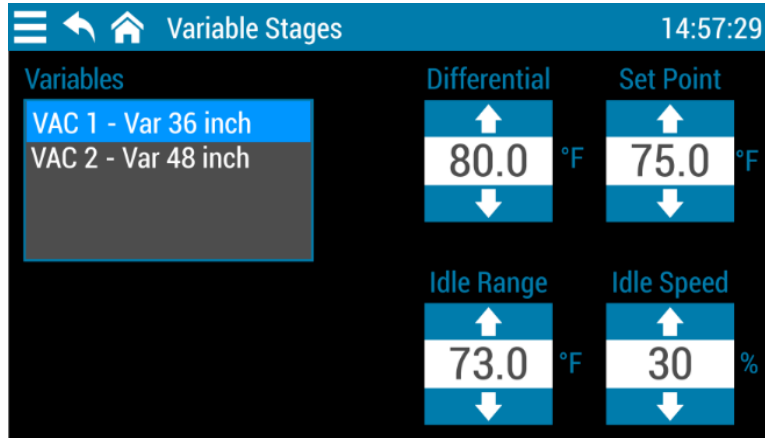

To program variable stages for ventilation

1. Press the **Menu** and then **Settings**.
2. Press **Staged Ventilation**.
3. Press **Variable Stages**
4. Press stage you want to program.
5. Press the **Up** or **Down** arrows to adjust the settings.
6. Press **Save** when you are finished.

Programming variable heating stages

Before setting up the variable stages, make sure you have properly configured them. For more information, read **Configuring variable stages** on page 30.

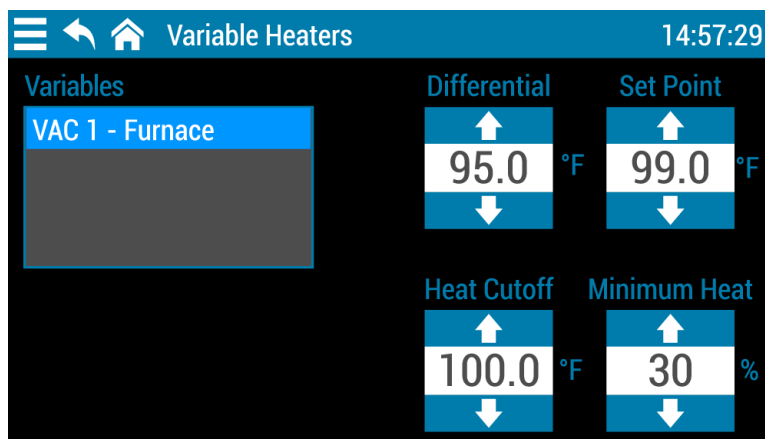

How variable heating stages work

- ◆ When the temperature is above the **heat cutoff** temperature, the heater is off.
- ◆ When the temperature drops below the **heat cutoff** temperature, the heater is at the **minimum heat**. The heater operates at **minimum heat** until the temperature drops to the **set point**.
- ◆ When the temperature is between the **set point** and the **differential** temperatures, heater output increases or decreases proportionally with the temperature.
- ◆ When the temperature is below the **differential** temperature, the heater is at full output.

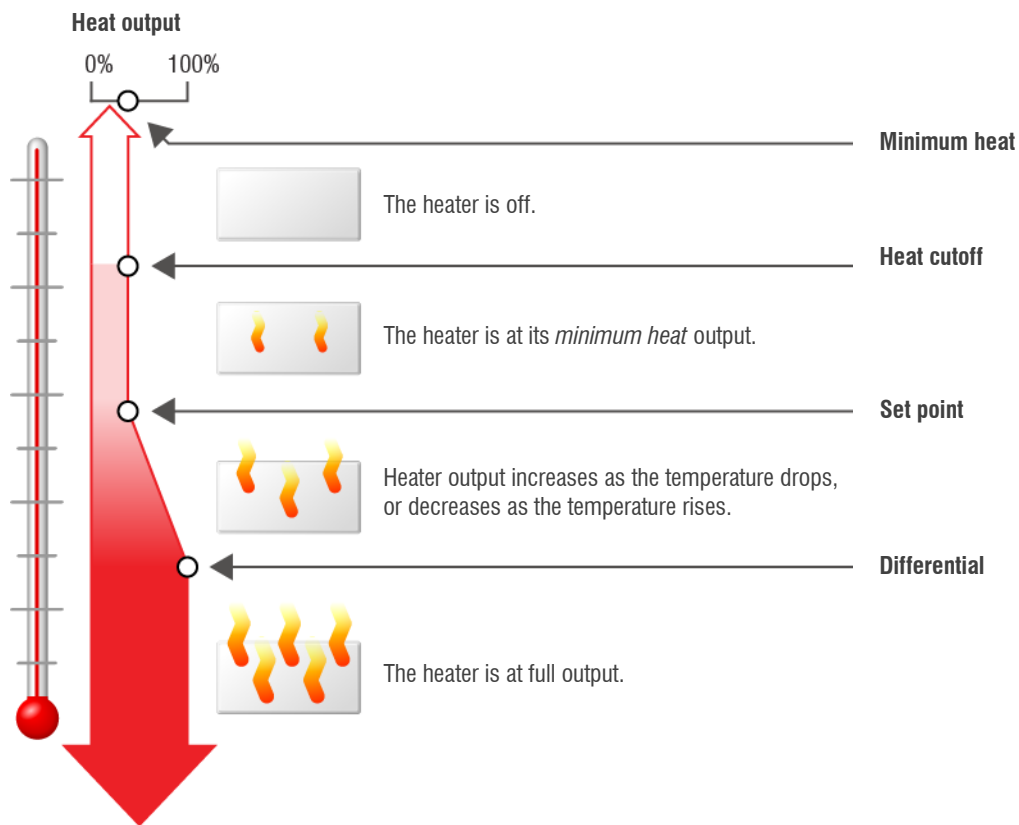

Use the **Variable stage settings worksheet** on page 86 when programming variable stages.

To program variable stages for heating

1. Press the **Menu** and then **Settings**.
2. Press **Heating**.
3. Press **Variable Stages**
4. Press stage you want to program.
5. Press the **Up** or **Down** arrows to adjust the settings.
6. Press **Save** when you are finished.

Programming inlet actuators

Before programming the inlet actuator relays, make sure you have properly configured the relays and calibrated the actuators. For more information, read **Configuring relays for inlet actuators or curtains** on page 32 and **Calibrating inlet actuators** on page 33.

How inlets work

- ◆ When the temperature is below the minimum set point, the inlet is closed.
- ◆ When the temperature rises to the minimum set point, the inlet moves to the minimum position.
- ◆ As the temperature rises, the inlet moves through the stages until it reaches its maximum open position. This method lets you gradually open inlets instead of fully opening them when the temperature rises above a single set point.

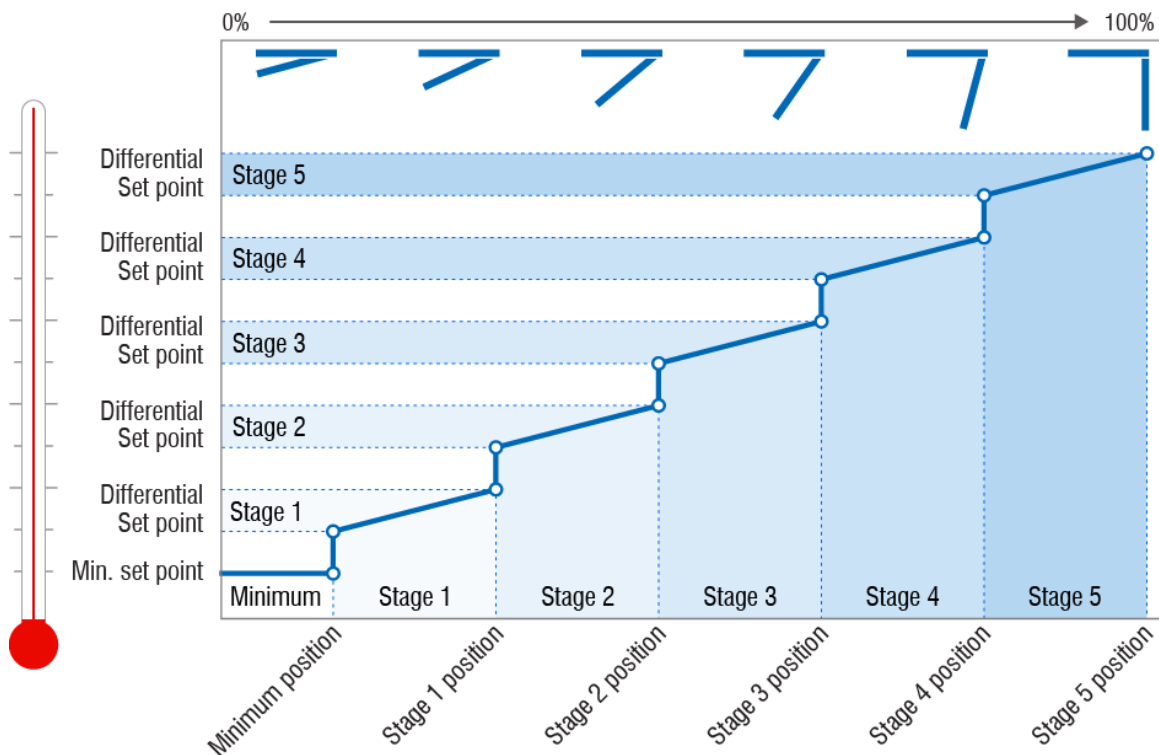

For example, you might decide to have the inlet open to 40 percent at stage 1, 60 percent at stage 2, 80 percent at stage 3, 90 percent at stage 4, and 100 percent at stage 5.

However, you don't want the inlet to open directly to 40 percent. That is why there are two temperature settings for each stage. The first setting is the stage set point. This is where the inlet starts opening. The second setting is the differential. This is where the inlet reaches the stage position.



- ◇ Use actuator control for actuators or curtain machines **only if they have feedback**. Using actuator control for motors without feedback can burn them out.
- ◇ For information about programming actuators or curtain machines without potentiometers, read **Programming curtain control relays** on page 52.

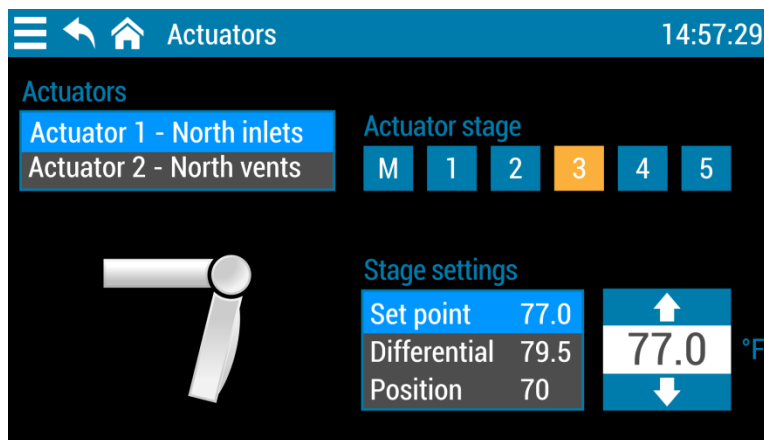

To program inlet actuators

1. Press the **Menu** and then **Settings**.
2. Press **Staged Ventilation**.
3. Press **Actuators**
4. Press the actuator and stage you want to program. It is best to program them in order, from minimum to 5.
5. Press **Set point** and then the **Up** or **Down** arrows to adjust the setting. Repeat this step for each setting.
6. Press **Save** when you are finished.

Programming curtain control relays

Curtains control the temperature by adjusting air flow into the facility, with the idea that more air cools the building.

How curtains work

- ◆ Curtains hold their position while the temperature is within the **idle band** of the **set point**. For example, if the **set point** is 80°F and the **idle band** is 4°F (+2°/-2°), the curtain holds its position when the temperature is between 78°F and 82°F.
- ◆ If the temperature rises above the **idle band** (above 82°F in our example), the curtain opens for the **open run duration**. After opening, the curtain holds its position for the **open idle duration**. If the temperature is still above the **idle band**, the curtain again opens for the **open run duration** and the process repeats.
- ◆ If the temperature drops below the **idle band** (below 78°F in our example), the curtain closes for the **close run duration**. After closing, the curtain holds its position for the **close idle duration**. If the temperature is still below the **idle band**, the curtain again closes for the **close run duration** and the process repeats.

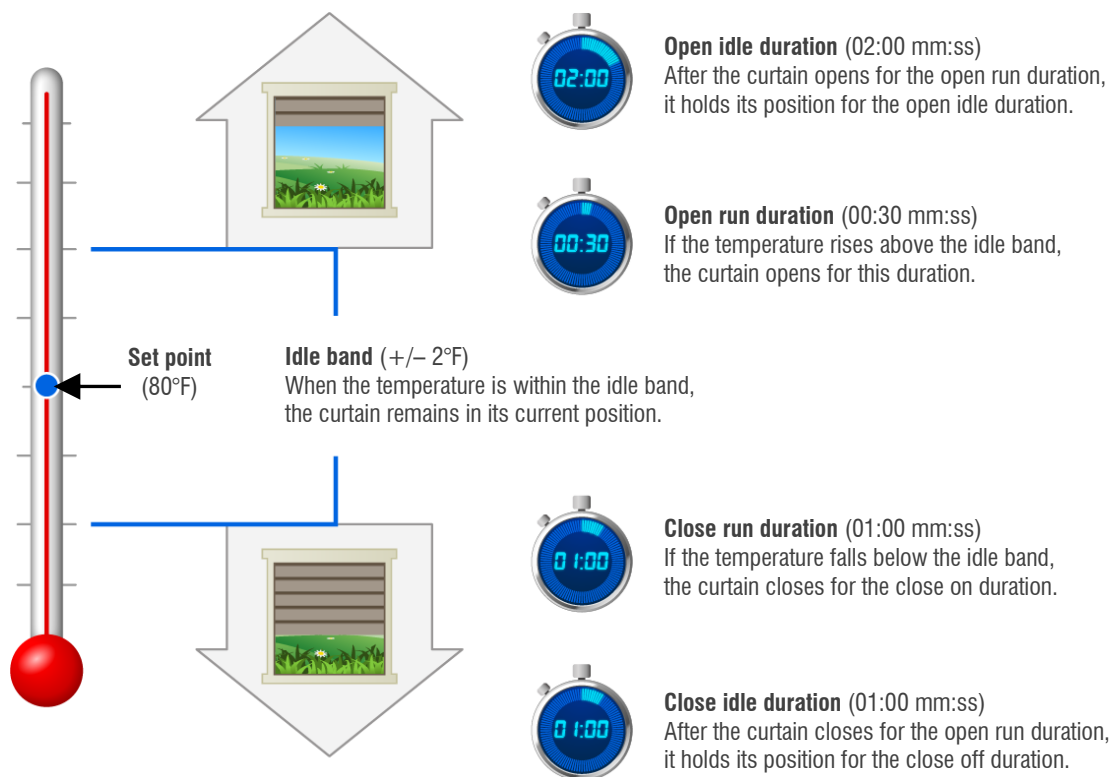

Use the **Curtain worksheet** on page 88 when setting up curtains.

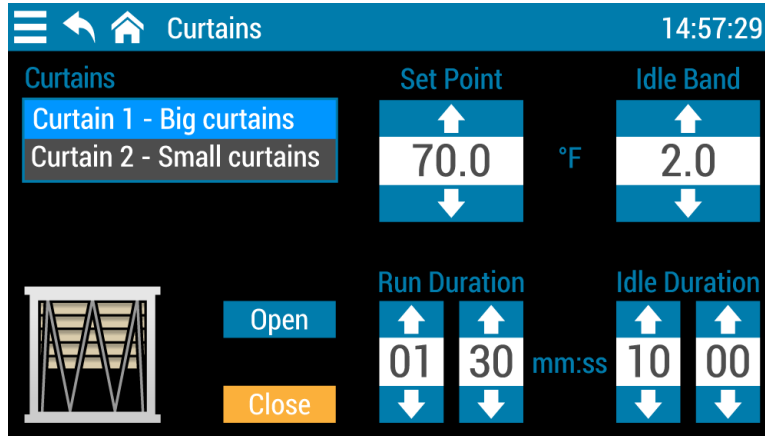

To program curtain machines

1. Press the **Menu** and then **Settings**.
2. Press **Staged Ventilation**.
3. Press **Curtains**
4. Press the curtain you want to program.
5. Press the **Up** or **Down** arrows to adjust the set point and idle band; they are the same for open and close.
6. Press the **Up** or **Down** arrows to adjust the OPEN run and idle durations.
7. Press **Close**.
8. Press the **Up** or **Down** arrows to adjust the CLOSE run and idle durations.
9. Press **Save** when you are finished.

Programming air curtains

Air curtain blowers have three main settings:

- ◆ **Open set point** is the temperature at which the selected blower switches off and the airbag opens.
- ◆ **Close set point** is the temperature at which the selected blower switches on and the airbag closes.
- ◆ **Blower delay** is the duration Supra Touch waits between inflating or deflating each air bag. The blower delay is the same for all blowers.

Default: 120 seconds *Range:* 1 to 600 seconds

How air curtains work

- ◆ When the temperature is below the **close set point** for the last blower (6 in the diagram below), all blowers are on and all airbags are closed.
- ◆ When the temperature rises above the **open set point** for blower 6, the blower shuts off and the airbag opens. Supra Touch then waits for the blower delay.
- ◆ After the **blower delay**, Supra Touch reads the temperature and then:
 - ◆ If the temperature is stable, it leaves the blowers as they are.
 - ◆ If the temperature rises above the open set point for the next blower, that blower shuts off and the airbag opens.
 - ◆ If the temperature falls below the close set point, that blower switches on and the airbag closes.

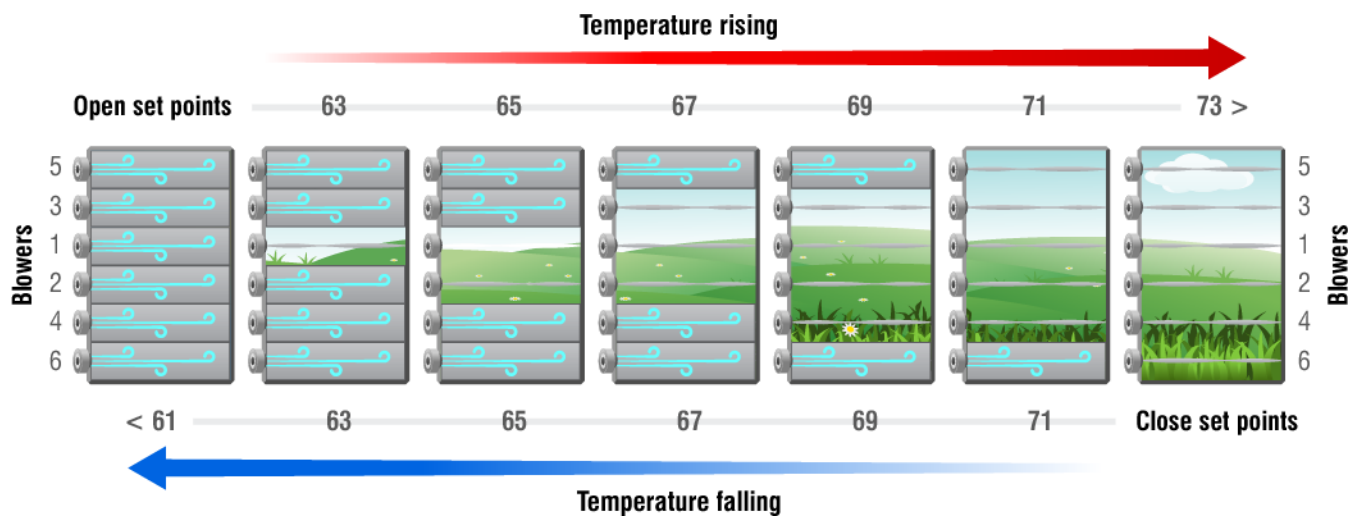

- ◇ The open and close set points must increase as the blower number increases. In other words, the set points for blower 3 must be higher than the ones for blower 2, which must be higher than blower 1, and so on.
- ◇ The open order is always 1-2-3-4-5-6 and the close order is always 6-5-4-3-2-1.

To program air curtain blowers

1. Press the **Menu** and then **Settings**.
2. Press **Staged Ventilation**.
3. Press **Air Curtain Settings**
4. Press the air curtain you want to program.
The settings screen displays.

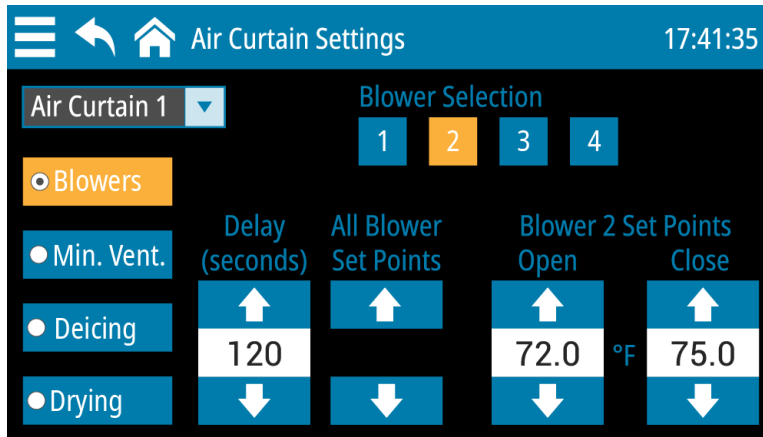

5. Set blower delay by pressing the **Up** or **Down** arrows below Delay. The delay duration is the same for all blowers in the air curtain.
6. Adjust the open and close set points. You can adjust the set points for individual blowers or for all at the same time.

Individual blower set points

- a. Press **Blowers**.
- b. Press the blower you want to program.
- c. Press the **Up** or **Down** arrows below Blower Set Points.
- d. Repeat steps b and c for each blower you want the program.

All blower set points

- a. Press **Blowers**.
- b. Press the **Up** or **Down** arrows below Blower Set Points.
Supra Touch will adjust *all blower set points* by the same amount.

7. Press **Save** when you are finished.

Air curtain minimum ventilation

The purpose of minimum ventilation is to allow the minimum amount of airflow required for the facility, even when the air curtains would normally be closed. Minimum ventilation can be active when the zone temperature is below the last blower's (last one that closes/first one that opens) close set point and all curtains in the zone are closed.

There are two settings for minimum ventilation:

- ◆ **Open duration** is how long the blower is off and the airbag is deflated.

Range: 5 to 120 seconds *Default:* 120 seconds

- ◆ **Cycle duration** is the total of all open durations, plus any additional time. For example, if you have 3 curtains and an open duration of 20 seconds, you must have your cycle duration at least 60 seconds.

Range: 2 to 600 minutes

How it works

When the zone temperature has been below the last blower's **close set point** for the **cycle duration**, the last blower of the first curtain will switch off for the open duration, allowing the air bag to deflate. After the open duration, the blower will switch on again.

Each curtain in the zone will go through the sequence. After the last curtain has gone, the Supra Touch waits for any remaining time in the cycle duration before starting the process again at the first curtain. The curtains will return to normal operation when the zone temperature rises above the lower limit of the idle band.



Minimum ventilation applies to *all* air curtains in the zone.

Low temperature cutoff

Low temperature cutoff stops minimum ventilation when the temperature is below the **stop temperature**. If you have an outdoor sensor, you can use low temperature cutoff.

Range: 0 to 125°F (-17.7 to 51.6°C) *Default:* 32°F (0°C)

Program minimum ventilation

1. Press the **Menu** and then **Settings**.
2. Press **Staged Ventilation**.
3. Press **Air Curtain Settings**
4. Press the air curtain you want to program.
5. Press **Min Vent**.

The Minimum Ventilation and Low Temperature Cutoff boxes must be checked to enable those options and display the settings.

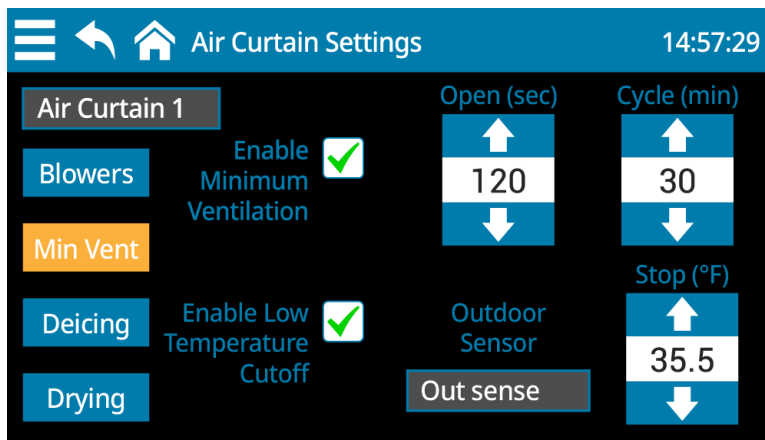

6. Set the durations by pressing the **Up** or **Down** arrows below Open and Cycle.
7. If you will be using low temperature cutoff, select the outdoor sensor. Set the cutoff temperature by pressing the **Up** or **Down** arrows below Stop
8. Press **Save** when you are finished.

Air curtain deicing

The purpose of deicing is to inflate and deflate the air bags when the outdoor temperature is low to prevent ice buildup. There are four settings for deicing:

- ◆ **Open duration** is how long the blower is off and the airbag is deflated.
Range: 5 to 120 seconds *Default:* 120 seconds
- ◆ **Cycle duration** is the total of all open durations, plus any additional time. For example, if you have 3 curtains and an open duration of 20 seconds, you must have your cycle duration at least 60 seconds.
Range: 2 to 600 minutes
- ◆ **Start temperature** - when the outdoor temperature is below the start temperature, deicing *will* occur.
Range: 14 to 122°F (-10 to 50°C) *Default:* 32°F (0°C)
- ◆ **Stop temperature** - when the outdoor temperature is above the stop temperature, deicing *will not* occur.
Range: 14 to 122°F (-10 to 50°C) *Default:* 32°F (0°C)

How it works

When the outdoor temperature has been below the start temperature for the cycle duration, the last blower of the first curtain will switch off for the open duration. After the open duration, the blower will switch on again.

Each curtain in the zone will go through the sequence. After the last curtain has gone, the system waits for the remaining time in the cycle duration before starting the process again at the first curtain. The system will return to normal operation when the outdoor temperature goes above the stop temperature.



Deicing applies to *all* air curtains in the zone.

Program the deicing

1. Press the **Menu** and then **Settings**.
2. Press **Staged Ventilation**.
3. Press **Air Curtain Settings**
4. Press the air curtain you want to program.
5. Press **Deicing**.
Enable Deicing must be checked to display the settings.

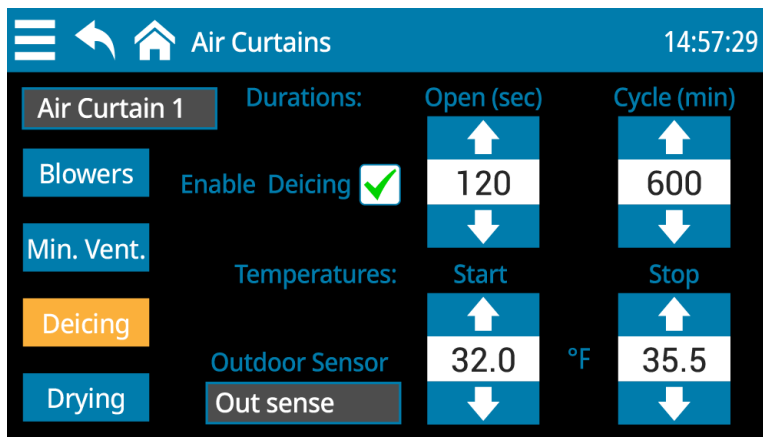

6. Set the durations by pressing the **Up** or **Down** arrows below Open and Cycle.
7. Select the outdoor sensor to use for the temperature range.
8. Set the temperature range by pressing the **Up** or **Down** arrows below Start and Stop.
9. Press **Save** when you are finished.

Air curtain drying

The purpose of air curtain drying is to prevent moisture problems that can occur when the air bags remain collapsed for long periods during warmer weather. You choose the time of day the drying cycle occurs and how many days are between each drying cycle. There are two settings for deicing:

- ◆ **Drying time** is the time of day the drying cycle will occur each day it is scheduled. The time is in 24-hour time

Default: 09:00

- ◆ **Drying frequency** is how often the drying cycle will occur. If you set it to 5, a drying cycle will occur every 5 days at the drying time.

Default: 1 day *Range:* 1 to 14 days

- ◆ **Drying duration** is how long the blowers for each curtain in the zone will switch on.

Default: 2 minutes *Range:* 5 seconds to 2 minutes, in 5-second intervals

How it works

When the drying cycle starts, all blowers for the first curtain in the zone switch on and inflate the air bags for the drying duration. At the end of the drying duration, the curtain returns to normal operation and the second curtain in the zone starts its drying cycle. The process repeats until all curtains in the zone have completed drying.



Drying applies to *all* air curtains in the zone.

Program the drying cycle

1. Press the **Menu** and then **Settings**.
2. Press **Staged Ventilation**.
3. Press **Air Curtain Settings**
4. Press the air curtain you want to program.
5. Press **Drying**.
Enable Drying must be checked to display the settings.

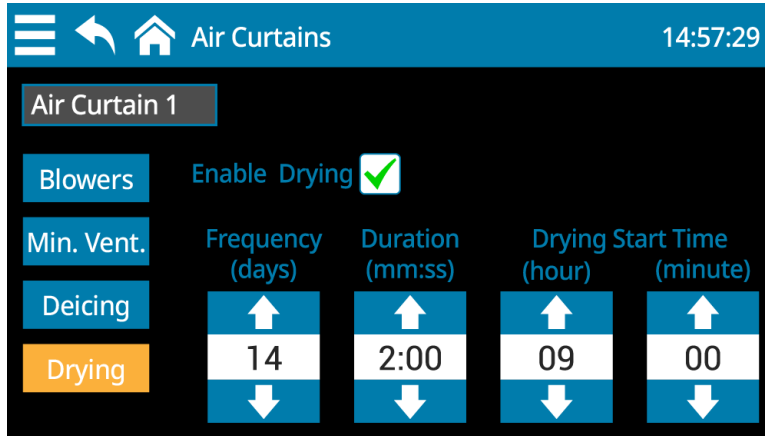

6. Set how often you want drying to occur by pressing the **Up** or **Down** arrows below Frequency.
7. Set how long you want the drying cycle to last by pressing the **Up** or **Down** arrows below Duration.
8. Set the time of day for the drying cycle by pressing the **Up** or **Down** arrows below Drying Start Time.
9. Press **Save** when you are finished.

Programming relay stages

Programming relay stages means setting temperature set points for relays to control equipment for ventilation or heating.



- ◇ Before programming relay stages, make sure you have properly configured the relays. For more information, read **Configuring relays** on page 31.
- ◇ Use the **Heating, cooling, and duty cycle relay worksheet** on page 90 when setting up heating and cooling equipment.

To program relays for cooling

1. Press the **Menu** and then **Settings**.
2. Press **Staged Ventilation**.
3. Press **Relay Stages**.
4. Press the relay you want to program.
5. Press the **Up** or **Down** arrows to adjust the set point.
6. Press **Save** when you are finished.

To program relays for heating

1. Press the **Menu** and then **Settings**.
2. Press **Heating**.
3. Press **Staged Heat**.
4. Press the relay you want to program.
5. Press the **Up** or **Down** arrows to adjust the set point.
6. Press **Save** when you are finished.

Programming duty cycles

A duty cycle switches equipment on and then off for specific durations, constantly repeating the same process.

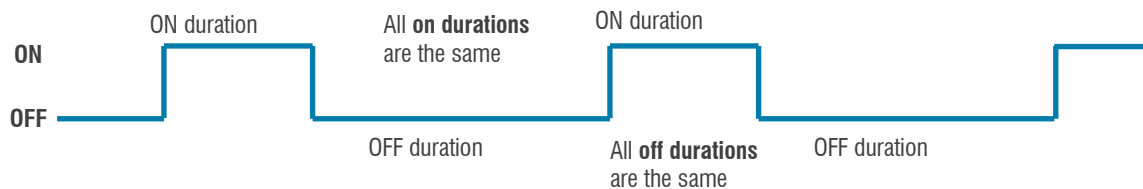

There are three types of duty cycles: **temperature based**, **time based**, and **persistent**.

Temperature based

A temperature-based duty cycle has an on duration, an off duration, and a temperature set point. A temperature-based duty cycle operates when the temperature is above the set point for cooling, and below the set point for heating.

For cooling, the equipment switches on for the on duration and then off for the off duration only when the temperature is above the set point. For a heating duty cycle, equipment switches on and off only when the temperature is below the set point.

Time based

A time-based duty cycle has an on duration, an off duration, a start time, and a stop time. A time-based duty cycle operates equipment only during defined times of the day. For example, you can have a duty cycle that is on for 5 minutes and then off for 10 minutes between 8 AM and 5 PM.

Persistent

A persistent duty cycle has an on duration and an off duration. A persistent duty cycle operates equipment at all times and temperatures.



- ◇ Before programming duty cycles, make sure you have properly configured the relays. For more information, read **Configuring relays** on page 31.
- ◇ Use the **Heating, cooling, and duty cycle relay worksheet** on page 90 when setting up heating and cooling equipment.

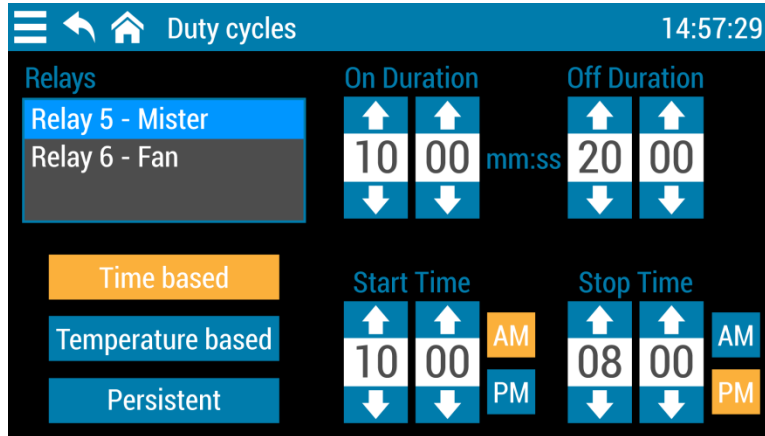

To program cooling duty cycles

1. Press the **Menu** and then **Settings**.
2. Press **Staged Ventilation**.
3. Press **Duty Cycles**.
4. Press the relay you want to program.
5. Press type of duty cycle you want.
The displayed settings change depending which duty cycle you select.
6. Press the **Up** or **Down** arrows to adjust each of the settings.
7. Press **Save** when you are finished.

To program heating duty cycles

1. Press the **Menu** and then **Settings**.
2. Press **Heating**.
3. Press **Duty Cycles**.
4. Press the relay you want to program.
5. Press type of duty cycle you want.
The displayed settings change depending which duty cycle you select.
6. Press the **Up** or **Down** arrows to adjust each of the settings.
7. Press **Save** when you are finished.

Using settings groups

Settings groups allow you to have different configuration and settings for different situations. For example, you can have a settings group for each of the different seasons. When you transition from one season to another, you can switch to another group without having to reprogram the control each time.

You can create up to four settings groups. Each group has its own settings and configuration. All settings and configuration except date, time, and screen lock can be different for each group.

Only one settings group can be active. Changes you make in any of the settings and configuration screens will apply only to the active group. You can scroll through each group and view the zone control configuration by pressing the left or right arrows. To view the other settings and configuration, go to the screen for those items.

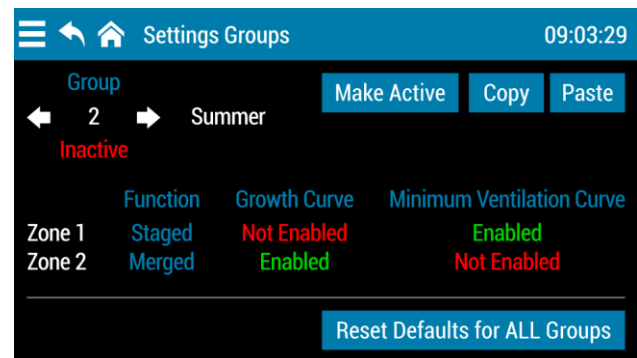
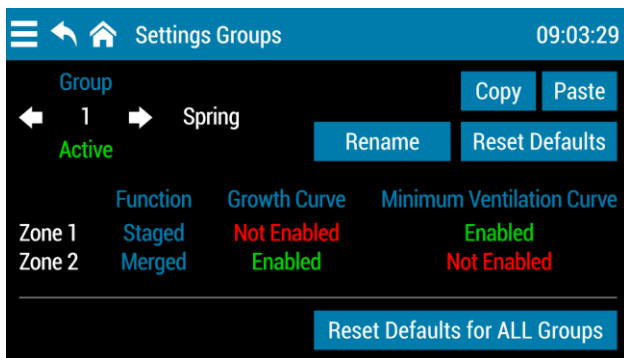

To activate a group

1. Press the **Menu** and then **Settings**.
2. Press **Configure Settings Groups**.
3. Scroll to the group you want to activate and then press **Make Active**.
The control will restart and then the selected settings group will be active.

To rename a group

1. Make sure the group you want to rename is the active group.
2. Press **Rename**.
3. Press **Reset** and then type the new name. When finished, press **Confirm** to save the change and return to the Settings Groups screen.
4. To restore the factory defaults for the group, press **Yes**. To cancel, press **No**.

To copy settings from one group to another

1. Scroll to the group you want to copy the settings from.
2. Press **Copy**. Confirm by pressing **Yes**.
3. Scroll to the group you want to copy the settings to.
4. Press **Paste**. Confirm by pressing **Yes**.

To reset the active group to factory defaults

1. Make sure the group you want to reset is the active group.
2. Press **Reset Defaults**.
A confirmation and warning message displays.
3. To restore the factory defaults for the group, press **Yes**. To cancel, press **No**.

To reset all groups to factory defaults

1. Press **Reset Defaults for ALL Groups**.
A confirmation and warning message displays.
2. To restore factory defaults for all groups, press **Yes**. To cancel, press **No**.

Chapter 5: Monitoring and maintaining your Supra Touch

- ◆ **Monitoring the Status screen** below
- ◆ **Testing sensors and equipment** on page 67
- ◆ **Using screen lock security** on page 68
- ◆ **Servicing and maintaining your Supra Touch** on page 69

Monitoring the Status screen

The Status screen displays information about each sensor and piece of equipment. Monitoring the control regularly gives you a better idea of what is going on in your facility.

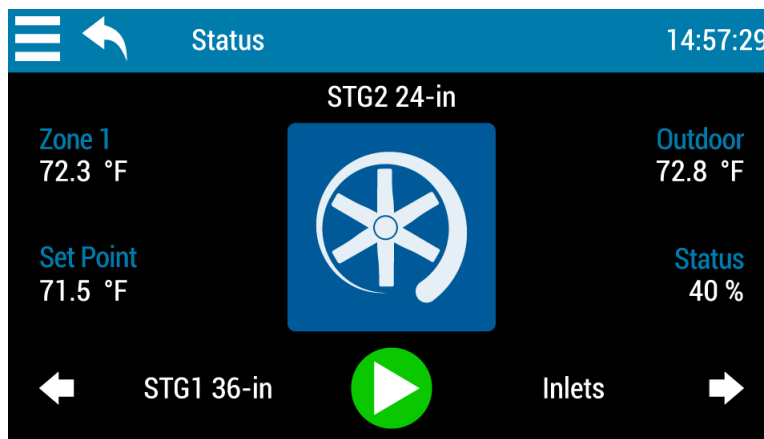

Each sensor or piece of equipment has its own status screen. Supra Touch automatically scrolls through each screen.

- ◆ To manually scroll through the screens, press the Left or Right arrows.
- ◆ To stop or start scrolling, press the **Pause/Play** button.

In the center of each status screen is a widget button. The following tables list the meaning of the button colors and icons.

Status indicators

	Light gray A sensor in normal status		Dark gray Equipment that is off
	Blue Ventilation equipment that is on		Orange Heating equipment that is on
	Green Equipment or sensor that is in manual override		Purple Equipment that is affected by a modifier
	Red Equipment or sensor that has an alarm condition		

Equipment icons



Variable cooling



Relay cooling



Relay cooling duty cycle



Relay follow variable cooling



Relay follow relay cooling



Actuator / inlet with feedback



Air curtain



Variable heating



Relay heating



Relay heating duty cycles



Relay follow variable heating



Relay follow a relay heating



Curtain / inlet without feedback

Sensor icons



Temperature



Ammonia



Light



Wind speed



Humidity



Carbon dioxide



Water meter

Widgets

Pressing the widget button in the center of the status screen takes you to the widget screen for the selected sensor or piece of equipment. Widget screens allow you to do some of the following, depending on the type of sensor or equipment:

- ◆ Switch between automatic and manual control
- ◆ Go to settings, modifiers, and alarms screens for the sensor or equipment.
- ◆ Calibrate and unjam actuators.
- ◆ View the current day's high and low readings for sensors.

Acknowledging alarms

An alarm occurs if an enabled alarm condition is present for longer than the minimum duration of one minute. The one-minute minimum duration prevents alarms from occurring when the temperature rises or falls or just a few seconds. The exceptions to the one minute minimum are the actuator jam alarms. Actuator jam alarms activate 20 seconds after the alarm is detected.

When an alarm occurs, the alarm relay triggers (switches) and a message flashes on the screen.

To acknowledge alarms

Press **Dismiss** to silence the alarm, or **Go to Alarms** to silence and then go to alarm settings.



- ◇ Acknowledging alarms clears the alarm message; it does not deactivate the alarm relay. To deactivate the alarm relay, resolve the problem causing the alarm condition.
- ◇ If you acknowledge the alarm, but do not resolve the problem causing the alarm condition, the alarm message displays again after the alarm silencing duration. For more information, read **Configuring alarm silencing** on page 27.

Testing sensors and equipment

Using manual override

Manual override allows you to override one or more sensors or pieces of equipment. Manual override is useful for testing equipment and settings, or for diagnosing problems.

- ◆ For variables, you can adjust the output.
- ◆ For relays and curtains, the state
- ◆ For actuators, the position
- ◆ For sensors, the sensor reading.

To override sensors or equipment

Option 1 - single sensor or piece of equipment

1. If you are on any screen other than the Status screen, press the **Home** button.
2. Press the Left or Right arrows to select sensor or equipment you want to override.
3. Press the widget button (the colored button in the center of the screen).
4. Press the **Up** or **Down** arrows to adjust the state, output, or reading.
Supra Touch automatically puts the item to manual override.
5. When finished, press **Auto** to return to automatic mode.

Option 2 – single or multiple sensors or equipment

1. Press the **Menu** and then **Manual Override**.
2. Press the sensor or piece of equipment you want to override.
3. Press the **Up** or **Down** arrows to adjust the state, output, or reading.
Supra Touch automatically puts the item to manual override and displays a manual override icon.
4. Repeat steps 2 and 3 for each sensor and piece of equipment you want to override.
5. When finished, press **Auto** to return the selected equipment to automatic, or **Auto All** to return all equipment.



When finished testing and overriding, set all sensors and equipment to automatic control. Any sensors or equipment you do not set to automatic will not function according to normal, programmed settings and will remain in manual override.

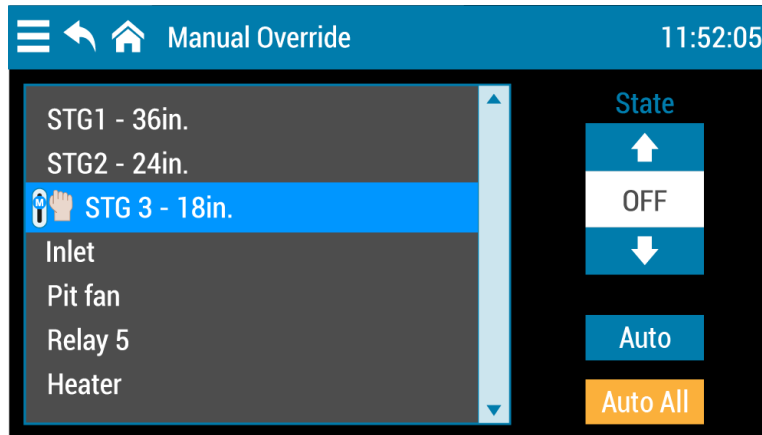

Testing a zone's sensors and equipment

Overriding a zone sensor allows you to test a zone's equipment and settings by simulating a range of temperatures for the zone. As you increase or decrease the test temperature, the variables and relays operate according to their programmed settings and the test temperature. This gives you an idea of how your system performs over a full range of temperatures.

To test a zone

Follow the steps in **Using manual override** on page 67 and choose the zone sensor at the item you want to override.

Using screen lock security

The Supra Touch has a screen lock feature you can use to control who makes changes to the control's settings. By default, screen lock is not enabled.

While screen lock is enabled, users must enter the PIN before they can access any of the control's functions, except the main status screen. After entering the PIN, users will not be asked again until the user locks the screen. The PIN number is a four-digit number you choose.

Locked override option

When the locked override option is enabled, users will be able to manually override equipment while the screen lock is enabled, even without entering a PIN. They will not be able to access any other functions.

To lock the screen

Press the **Menu** and then **Screen Lock**.

To unlock the screen

1. Press the **Lock** and then enter the four-digit PIN.
2. Press **Unlock Screen**.

To enable and configure screen lock security

1. Press the **Menu** and then **Administration**.
2. Press **Configure Screen Lock**.
 - ◆ To enter a new PIN, press a new four-digit number. The control will accept the last four numbers you press.
 - ◆ To enable or disable screen lock or the locked override option, press the **Enabled** or **Disabled** button for that option.

Press **Save** when you are finished.



If the PIN has been forgotten and nobody can access the control, contact your dealer.

Servicing and maintaining your Supra Touch

Restoring the factory defaults

The Supra Touch leaves the factory with default configuration and settings. Resetting the Supra Touch erases all the configuration and settings you programmed and restores them to what they were when the control left the factory. For a list of the factory defaults, read **Appendix B: Factory defaults** on page 79.



- ◇ **Restore the factory defaults only as a last resort. It erases ALL your configuration and settings and you will have to reconfigure the control.**
- ◇ If you restore the Supra Touch to its factory defaults, disconnect the power to all loads and then reconfigure the control before restoring power to the loads.

To restore the factory defaults

1. Press the **Menu** and then **Administration**.
2. Press **Restore Defaults**.
3. To restore defaults and remove all your configuration and settings, press **Yes**. To cancel and return to the menu, press **No**.

Saving and restoring settings

You can save or restore (load) your settings and configuration from any USB drive. You can also transfer them to any Supra Touch and set up new controls in seconds.



- ◇ We recommend regularly saving your configuration and settings to a USB drive and then keeping the drive in a safe place. This allows you to quickly set up new controls or recover your information if you install a display kit.



- ◇ The file created when saving settings to USB contains **all four settings groups** in one file.
- ◇ When you load settings from USB, the control overwrites **all four settings groups**, and then restarts. The settings group that was active before restarting will again be active.
- ◇ For more information about settings groups, read **Using settings groups** on page 63.

To save to USB

1. Loosen the four screws in the Supra Touch enclosure and then gently remove the cover. Be careful not to disconnect the ribbon cable.
2. Insert a USB drive into the USB port on the inside of the cover.
3. Press the **Menu** and then **Administration**.
4. Press **Save to USB**.
5. To save the configuration and settings, press **Yes**. To cancel and return to the menu, press **No**.
6. Remove the USB drive.
7. Replace the cover and then tighten the four screws.

To load from USB

1. Loosen the four screws in the Supra Touch enclosure and then gently remove the cover. Be careful not to disconnect the ribbon cable.
2. Insert the USB drive containing the configuration and settings into the USB port on the inside of the cover.
3. Press the **Menu** and then **Administration**.
4. Press **Load from USB**.
5. To load the saved configuration and settings, press **Yes**. To cancel and return to the menu, press **No**.
6. Remove the USB drive.
7. Replace the cover and then tighten the four screws.

Displaying version information

Firmware is like an operating system for your computer or mobile device. Firmware contains instructions that tell Supra Touch how it operates. Just like operating systems such as Windows or Android have version numbers, the Supra Touch firmware has a version number.

If you need to contact customer support about the Supra Touch, you might need to provide them with the firmware version of your control. For more information about technical support, read **Service and technical support** at the back of the manual.

The Supra Touch displays the firmware version as a number in the format v#.##.

To display version information

Press the **Menu** and then **About**.

Updating the firmware

Phason constantly improves and adds new features to their products. You can upgrade the firmware in your Supra Touch as these features become available. The update takes about 20 to 30 seconds.



You can download the latest firmware update file from www.phason.ca; just go to the **Downloads** or **Supra Touch** product page.



- ◇ The USB drive must be formatted as a **FAT32 file system**.
- ◇ You must copy the file to the **root** of the USB drive. The root means **not in a folder**.
- ◇ The following instructions are for a Windows computer.

To prepare the firmware update file

1. Insert the USB drive into your computer and then open Windows Explorer.
2. Right-click the USB drive
3. Select **Properties**.
4. Verify the file system is FAT32. If the file system is not correct, you will need to format the drive as FAT32, or use a different USB drive that is the correct format.
5. Copy the update file to the **root** of the USB drive.
6. Remove the drive.

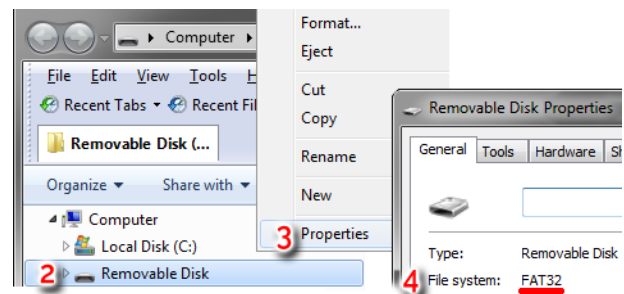

To update the firmware

1. Loosen the four screws in the Supra Touch enclosure and then gently remove the cover. Be careful not to disconnect the ribbon cable.
2. Insert the USB drive containing the update into the USB port on the inside of the cover.
3. Press the **Menu** and then **Administration**.
4. Press **Update Firmware**.
5. To update the firmware, press **Yes**. To cancel and return to the menu, press **No**.
6. After the update has finished, remove the USB drive.
7. Verify the control operates properly.
8. Replace the cover and then tighten the four screws.



If there is a problem during the update, leave the USB drive connected and follow these steps.

Switch off the power to the Supra Touch for 10 seconds, and then switch it on again. The control should automatically update when it restarts.

Replacement kits and optional accessories

Replacement kits and several optional, convenient accessories are available to enhance and extend the Supra Touch.

Parts and kits

Display kit

If the Supra Touch display fails, you can replace it with a kit. The display kit is model **KST-DISPLAY**. After replacing the display, you will need to configure and program control.



If you have saved your configuration and settings to a USB drive, you can restore them instead of having to reconfigure and program the control.

Control kits

If the bottom circuit board of the Supra Touch control fails, you can replace it with a kit. The control kit is model **KST-CONTROL**.

Replacement relays

You can buy packages of replacement relays. Each relay package has five relays. The package is model number **PKG-R52**.

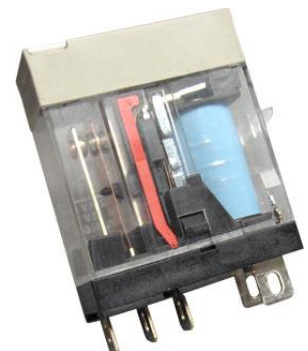

Additional sensors

Phason 3K probes and extension cable

Phason 3K temperature probes monitor temperatures ranging from -49 to 122°F (-45 to 50°C). The probes are available in 1, 6, 30, 75, or 150-foot cable lengths and can be extended up to 500. Extension cable is available in 500-foot lengths.



DOL 16 Light Sensor

The DOL16 Light Sensor measures light intensity in two different ranges: 0 to 100 and 0 to 1000 lux. The DOL16 has very low output resistance and full protection against short circuits and wiring failures. The microprocessor-controlled sensor has a two-color status and diagnostic LED.



DOL 114 Temperature and Humidity Sensor

The DOL 114 is a high-precision temperature and relative humidity sensor. The special sensor element and the built-in Teflon filter enables application in facilities with constantly high humidity.

The microprocessor-controlled sensor has a two-color status and diagnostic LED. The sensor has two analog outputs with full protection against short circuits and wiring failures.



DOL 19 Carbon Dioxide Sensor

The DOL 19 sensor is designed to measure carbon dioxide (CO_2) in livestock and industrial facilities. The sensor's measuring range has been selected both to care for the animals' comfort and to monitor potential error conditions in livestock houses with direct combustion.

The non-dispersive infrared sensor is protected by a carefully selected filter and a rugged enclosure. A cable and quick connector make it easy to remove the sensor for cleaning and disinfection.



DOL 53 Ammonia Sensor

The DOL 53 was specifically designed to measure ammonia in livestock and industrial facilities. The long-life electrochemical will never need calibration and is not sensitive to other gases.

Accessories

Power contactors

The Manual Override Box (**model MOB-4**) increases the load handling capability of relays and provides an external disconnect. The MOB-4 includes four 240 V power contactor relays with AUTO-OFF-MANUAL switches and snubber filters. If you need to override an actuator or curtain machine, an actuator override kit is available.

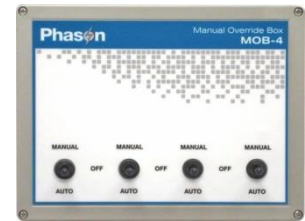

Variable DC Module

The Variable DC Module (**model VDC-4**) has four 0 to 10 V outputs for controlling variable frequency drives, FanDRIVES, or other equipment requiring a DC signal input.

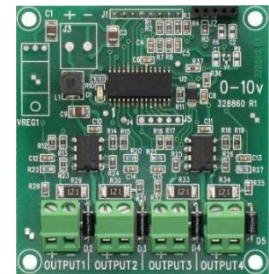

FanDRIVES

If you have the Variable DC Module, you can add FanDRIVES. FanDRIVES take the 0 to 10 V signal from the module and adjust fan speed. A 1×14 FLA model (**FD-1-14**) and a 2×7 FLA model (**FD-2-7**) are available.



Appendixes

- ◆ **Appendix A: Troubleshooting** below
- ◆ **Appendix B: Factory defaults** on page 79
- ◆ **Appendix C: Worksheets** on page 80
- ◆ **Appendix D: Motor curves** on page 92

Appendix A: Troubleshooting

The following table lists some possible causes and possible solutions for problems. See if a problem you are experiencing is described in the table and then follow the directions for correcting the problem.

Problem	Possible causes	Possible solutions
Cannot access the menu or settings	Screen lock security is enabled	Enter the correct PIN. For more information, read Unlocking the screen on page 7.
Power supply components blown out Burn marks on boards and components Motors and fans slow down or stop	Power surge, brownout, or power outage	Avoid the problem in future by providing proper voltage and protection for the control.
No power and/or display	A circuit breaker at service panel is off or tripped.	Reset the circuit breaker.
	Incorrect wiring	Correct the wiring.
	The display board connect cable is not plugged into the control board properly.	Plug in the display board cable. For more information, read Bottom layout on page 11.
	The 115/230 VAC switch is in the wrong position	Switch off the power, set the switch to the correct setting, and then switch on the power. For more information, read Bottom layout on page 11.
Temperature does not change	There are no working temperature probes enabled or connected	Make sure at least one working probe is enabled. For more information, read Configuring sensor inputs on page 28.
Unusually high or low temperature readings	A non-Phason probe is connected to TEMP 1/2/3/4	Remove the probe and then install a Phason probe.
	The extension cable connected to the temperature probe is providing a poor connection	Check the extension cable connection. Resolder it if necessary.
	Damaged probe	Replace the temperature probe.
Variable fan runs at maximum	Incorrect wiring	Correct the wiring. For more information, read Connecting variable heating or cooling equipment on page 17.

Problem	Possible causes	Possible solutions
	The minimum idle speed is too high.	Decrease the minimum idle speed setting. For more information, read Programming variable cooling stages on page 47.
	The on full at setting is the same as the temperature set point.	Adjust the temperature set point to the desired temperature. For more information, read Programming variable cooling stages on page 47.
	Incorrect motor curve	Configure the stage to use the other motor curve. For more information, read Configuring variable stages on page 30.
Variable fan not running	Incorrect wiring	Correct the wiring. For more information, read Connecting variable heating or cooling equipment on page 17.
	The fuse is open or blown.	Check why the fuse was blown and then repair any problems. Replace the fuse.
	The variable stage is configured as OFF	Configure the variable stage for cooling. For more information, read Configuring variable stages on page 30.
	The idle speed setting is too low.	Increase the idle speed setting. For more information, read Programming variable cooling stages on page 47. See also Programming minimum ventilation curves on page 39.
	The off at temperature setting is too high.	Decrease the off at temperature setting. For more information, read Programming variable cooling stages on page 47.
	The temperature set point is above room temperature.	Adjust the temperature set point to the desired temperature. For more information, read Programming variable cooling stages on page 47.
	There is no power to the fan.	Switch on the power.
	Faulty fan/heater	Replace the equipment.
	Circuit breaker open	Reset the breaker.
Variable speed 1 or variable speed 2 fan switches on, runs at full speed, and then turns off.	The hysteresis is not high enough. The outside temperature is rising and falling quickly. This happens most often in the spring and fall.	Adjust the hysteresis setting or overlap the variable speed 1 or variable speed 2 fan settings. For more information, read Configuring hysteresis on page 25.
Variable speed fan responds to only a small portion of the 0 to 100% range	Incorrect motor curve	Configure the stage to use the other motor curve. For more information, read Configuring variable stages on page 30.
Curtain opens when it should close or closes when it should open	Incorrect wiring, the close and open wires are reversed.	Correct the wiring. For more information, read Connecting curtain machines on page 15

Problem	Possible causes	Possible solutions
Staged heater cycles on and off	The heater set points are too close to the variable speed fan set points.	Adjust the set points to be farther apart. For more information, read Programming variable cooling stages on page 47, or Programming variable heating stages on page 48.
	The heater is too large for the room	Replace the heater with a smaller output unit.
	The stage is set up as a duty cycle	Configure the relay as heating. For more information, read Configuring relays , starting on page 31
Alarm relay not operating alarm system	Incorrect wiring	Correct the wiring. For more information, read Connecting an alarm system on page 18
Relay does not switch load on	Incorrect wiring	Correct the wiring. For more information, read the appropriate installation section.
	The relay is configured as OFF.	Configure the relay properly. For more information, read Configuring relays , starting on page 31.
	The set point is incorrect	Adjust the setting. For more information, read the appropriate programming section.
	The relay is configured as cool for a heater.	Change the configuration for the relay to heat. For more information, read Configuring relays , starting on page 31.
	The relay is configured as heat for a fan.	Change the configuration for the relay to cool. For more information, read Configuring relays , starting on page 31.
	No power to the load	Check the power and circuit breaker for the load.
	Faulty equipment	Manually test the equipment and repair or replace it if necessary.
	Blown relay	Solve the problem that caused the relay to blow and then replace the circuit board or use a different relay.

Determining correct actuator feedback wiring

After installing a new actuator or potentiometer, or due to age-related potentiometer wear, the actuator might not move correctly. Common symptoms include:

- ◆ The actuator oscillating back and forth
- ◆ The actuator not traveling the full stroke during calibration

The feedback potentiometer wiring must be properly connected to the control. Determining the correct wiring can be difficult on some actuators or potentiometers.

Potentiometers have three wires: positive (+), negative (-), and feedback (FB). If the feedback wire is not connected to the FB terminal on the control, the actuator will not function properly.

Because the wires are often different colors and are not always labeled the same as above, measuring the resistance between the wires is the best way to determine which wire is the feedback wire. Follow the steps below to measure the resistance and determine the correct wiring.



- ◆ Before checking the potentiometer wires, verify that the power wires are properly connected.
- ◆ Test the actuator using stage test mode.

1. Manually move the actuator away from the end of its stroke by at least a quarter of its total stroke.
2. Disconnect all three potentiometer wires from the control.
3. Number the wires 1, 2, and 3, in any order.
4. Set your ohmmeter to measure the potentiometer's maximum resistance, normally 20,000 Ω .
5. Measure and record the resistance between wires 1 and 2. _____ Ω
6. Measure and record the resistance between wires 1 and 3. _____ Ω
7. Measure and record the resistance between wires 2 and 3. _____ Ω
8. The pair of wires with the highest measured value are the positive and negative wires. Connect the wires to the positive and negative actuator terminals on the control. At this time, do not be concerned with which wire you connect to which terminal.
9. Connect the remaining wire to the feedback terminal.
10. Test the actuator using automatic mode to see if the control moves it properly. If the actuator moves in the opposite direction than it is supposed to, switch the positive and negative wires on the control.

Appendix B: Factory defaults

The Supra Touch leaves the factory with default configuration and settings. Resetting the Supra Touch erases all the configuration and settings you programmed and restores them to what they were when the control left the factory. For more information, read **Restoring the factory defaults** on page 69.

Configuration				Variable cooling			
Variables, inlets, and relays	Not configured			Differential	86.0°F		
Sensors	Not configured			Set point	80.0°F		
Zone function	Staged, curves not enabled			Idle range	75.0°F		
Temperature units	°F			Idle speed	20%		
Screen lock	Off			Variable heating			
Hysteresis	1.0			Differential	64.0°F		
Relay stagger	5 sec			Set point	70.0°F		
Alarm silencing	15 minutes			Heat cutoff	75.0°F		
				Minimum heat	20%		
Master set point							
Master set point	75.0°F						
Maintain other set points	off						
Growth curve				Ventilation curve			
Current day	0 / off			Current day	0 / off		
Restart day	64			Restart day	64		
Step 1	day 1	85.0°F		Step 1	day 1	20%	
Step 2	day 4	80.0°F		Step 2	day 4	25%	
Step 3	day 14	75.0°F		Step 3	day 14	30%	
Step 4	day 24	70.0°F		Step 4	day 24	35%	
Step 5	day 34	65.0°F		Step 5	day 34	40%	
Step 6	day 44	60.0°F		Step 6	day 44	45%	
Step 7	day 64	60.0°F		Step 7	day 64	50%	
Inlets				Alarm settings			
Min.	Set	72°F	Diff. -----	Pos	0%	High temperature	Not enabled 95.0°F
Stage 1		75°F			20%	Low temperature	Not enabled 60.0°F
Stage 2		79°F			40%	Compensation offset	Not enabled 5.0°F
Stage 3		81°F			60%	High maximum	Not enabled 98.0°F
Stage 4		83°F			80%	Probe damage	Not enabled
Stage 5		85°F			100%	Actuator jam	Not enabled

Appendix C: Worksheets

Installation worksheets



Use the **Installation worksheet** when you fill in the **Configuration worksheets** (starting on page 82).

Electrical ratings

Input power	120/230 VAC, 50/60 Hz
Variable AC stages ① [4: VAR1 to VAR4]	10 A at 120/230 VAC, general-purpose (resistive) 7 FLA at 120/230 VAC, PSC motor 1/2 HP at 120 VAC, 1 HP at 230 VAC, PSC motor
Fuses [4: F1 to F4]	15 A, 250 VAC ABC-type ceramic
Relays ① [12: RLY1 to RLY12]	10 A at 120/230 VAC, general-purpose (resistive) 1/3 HP at 120 VAC, 1/2 HP at 230 VAC 360 W tungsten at 120 VAC
Alarm relay	0.4 A at 125 VAC; 2 A at 30 VDC, resistive load 0.2 A at 125 VAC; 1 A at 30 VDC, inductive load

① You can connect more than one piece of equipment to a variable stage or relay as long as they are the same type (for example, two fans) and the total current draw does not exceed the stage's limit.



The FLA (full load ampere) rating accounts for the increase in motor current draw when the motor operates at less than full speed. Make sure the motor/equipment connected to the variable stage does not draw more than 7 FLA.

Input/output	Equipment to connect
--------------	----------------------

Example:

VAR1 36-inch variable speed fan, 2.5 FLA, 3/4 HP

VAR 1	① VDC 1
VAR 2	① VDC 2
VAR 3	① VDC 3
VAR 4	① VDC 4
RLY 1	RLY 7
RLY 2	RLY 8
RLY 3	RLY 9
RLY 4	RLY 10
RLY 5	RLY 11
RLY 6	RLY 12
ALARM	
② TEMP 1	② DOL TEMP
② TEMP 2	② DOL HUM
② TEMP 3	③ DOL AUX 1
② TEMP4	③ DOL AUX 2
① OUT TEMP	③ DOL AUX 3
⑤ COUNT	⑥ ANALOG

- ① Requires optional VDC-4 Variable DC Module
- ② Phason 3K Temperature sensor only
- ③ DOL 114 Temperature and Humidity sensor only
- ④ DOL 19 Carbon Dioxide, DOL 53 Ammonia, or DOL 16 Light sensors only
- ⑤ Phason WINDSPEED-03 Wind Speed sensor or water meter with a dry contact pulse output only
- ⑥ Phason RHS Relative Humidity sensor only

Configuration worksheets



Use the **Installation Worksheet** on page 80 when completing the configuration worksheets.

Main control function worksheet

Item	Description	Configuration		
Zone function	<p>There are two ventilation modes: <i>Staged</i> and <i>VentGrid Merged</i>.</p> <p>For more information, read Configuring the zone control mode on page 27.</p>	<i>Zone 1:</i>	Staged	Merged
		Growth curve	Yes	No
		Ventilation curve	Yes	No
		<i>Zone 2:</i>	Staged	Merged
		Growth curve	Yes	No
		Ventilation curve	Yes	No
Units		°C	°F	
Hysteresis	Hysteresis is number of degrees above the set point that a heating stage or relay switches off, and the number of degrees below the set point that a cooling stage or relay switches off.	_____	degrees	
Relay stagger	Relay stagger prevents several relays from switching on at the same time by offsetting each relay when the control starts.	_____	seconds	

Variable stage configuration worksheet

For each variable, fill in the information as shown in the example at the top. For configuration information, read **Configuring variable stages** on page 30.

Variable	Description	Zone	Cool	Motor curve	De-icing	Heat
<i>Example:</i>						
VAR 1	Stage 1 fan	1	✓	1	✓	
VAR 2	Heat mat	1				✓
VAR 1						
VAR 2						
VAR 3						
VAR 4						
VDC 1 ①						
VDC 2 ①						
VDC 3 ①						
VDC 4 ①						
① Requires optional VDC-4 Variable DC Module						

Relay configuration worksheet

For each relay, fill in the information as shown in the example table. For configuration information, read **Configuring relays** on page 31.

Example

Relay and description	Inlet 1 open	Inlet 1 close	With feedback	Inlet 2 open	Inlet 2 close	With feedback	Curtain open	Inlet close	Cool	Cool duty cycle	Heat	Heat duty cycle	Follow relay	Follow variable	Air curtain
1 <i>Inlet open</i>	✓		✓												
2 <i>Inlet close</i>		✓													
3 <i>36-inch fan</i>										✓					
4 <i>Electric heat</i>											✓				
5 <i>Pit fan</i>									✓						
6 <i>Sprinkler</i>														VAR2	

Worksheet

Relay and description	Inlet 1 open	Inlet 1 close	With feedback	Inlet 2 open	Inlet 2 close	With feedback	Curtain open	Curtain close	Air curtain	Cool	Cool duty cycle	Heat	Heat duty cycle	Follow relay	Follow variable
1															
2															
3															
4															
5															
6															
7															
8															
9															
10															
11															
12															

Settings worksheets

Settings worksheets are for you to use when programming the Supra Touch settings. Each worksheet contains a brief explanation of the information required. For more information about programming the Supra Touch, see **Chapter 4: Programming the Supra Touch** on page 34.

Growth curve worksheet

A growth curve automatically adjusts the temperature set points over time to control the temperature. You can have up to seven steps in a growth curve. Each step has a start date and temperature. Supra Touch automatically calculates the set points for the days between the steps and adjusts the set points at midnight each day. For more information, read **Programming growth curves** on page 37.

Step	Start day	Temperature
1		
2		
3		
4		
5		
6		
7		
Restart day		
Temperature range: -13 to 125°F (-25 to 51.7°C)		



Temperature set points must decrease as the steps increase.

Variable stage settings worksheet

For information about programming variable stage settings, read **Programming variable cooling stages** on page 47, or **Programming variable heating stages** on page 48.

Variable	Idle speed / Minimum heat	Idle range / Heat cutoff	Set point	Differential
VAR 1				
VAR 2				
VAC 3				
VAR 4				
VDC 1 ①				
VDC 2 ①				
VDC 3 ①				
VDC 4 ①				

① Requires optional VDC-4 Variable DC Module

Inlet actuator settings worksheet

The settings for the inlet actuators include the position, set point, and differential.

- ◆ When the temperature is below the minimum set point, the inlet is closed.
- ◆ When the temperature rises to the minimum set point, the inlet moves to the minimum position.
- ◆ As the temperature rises, the inlet moves through the stages until it reaches its maximum open position. This method lets you gradually open inlets instead of fully opening them when the temperature rises above a single set point.

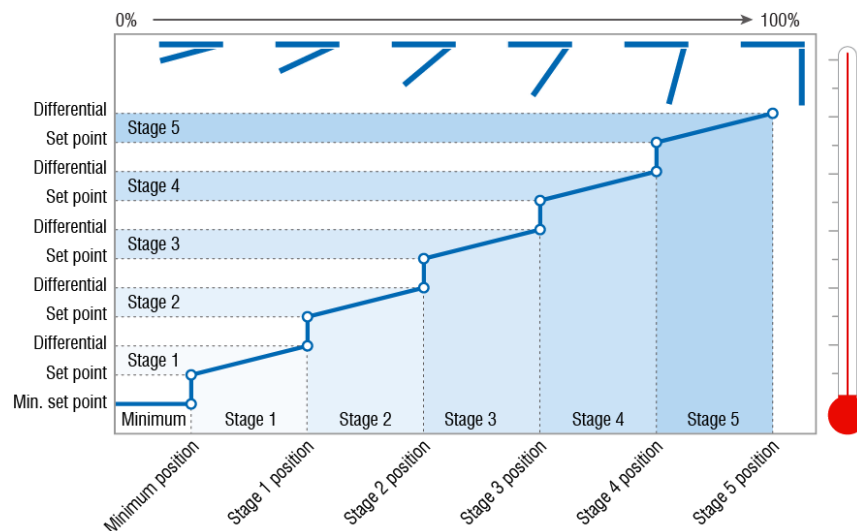

For more information, read **Programming inlet actuators** on page 50.

Setting	Actuator 1	Actuator 2	Description
Minimum			
Set point ①			The temperature below which the actuator is closed
Position ②			The percentage the actuator is open when the temperature is at or above the minimum set point
Stage 1			
Set point			The temperature at which the actuator starts opening for <i>stage 1</i>
Differential			The temperature at which the actuator is open to <i>stage 1 position</i>
Position			The percentage the actuator is open when the temperature is at the <i>stage 1 differential</i>
Stage 2			
Set point			The temperature at which the actuator starts opening for stage 2
Differential			The temperature at which the actuator is open to stage 2 position
Position			The percentage the actuator is open when the temperature is at the differential
Stage 3			
Set point			The temperature at which the actuator starts opening for stage 3
Differential			The temperature at which the actuator is open to stage 3 position
Position			The percentage the actuator is open when the temperature is at the differential
Stage 4			
Set point			The temperature at which the actuator starts opening for stage 4
Differential			The temperature at which the actuator is open to stage 4 position
Position			The percentage the actuator is open when the temperature is at the differential
Stage 5			
Set point			The temperature at which the actuator starts opening for stage 5
Differential			The temperature at which the actuator is open to stage 5 position
Position			The percentage the actuator is open when the temperature is at the differential
① Set point temperatures in °F/ °C, range: -13 to 125°F (-25 to 51.7°C) ② Positions in %, range: 0 to 100%			

Curtain worksheet

Curtains control the temperature by adjusting the air flow into the facility. Each curtain has six settings.

- ◆ **Set point** – the temperature at which the curtain holds its position.
- ◆ **Idle band** – the buffer around the set point within which the curtains hold their position.
- ◆ **Open run duration** – the duration the curtains open during the open cycle
- ◆ **Open idle duration** – the duration the curtains hold their position during the open cycle
- ◆ **Close run duration** – the duration the curtains close during the close cycle
- ◆ **Close idle duration** – the duration the curtains hold their position during the close cycle

For more information, read **Programming curtain control relays** on page 52.

Curtain	Set point ①	Idle band ②	Open run duration ③	Open idle duration ③	Close run duration ③	Close idle duration ③
			:	:	:	:
			:	:	:	:
			:	:	:	:
			:	:	:	:
			:	:	:	:
			:	:	:	:

① Temperature in °F/ °C, range: -13 to 125°F (-25 to 51.7°C)
 ② Temperature in °F/ °C, range: 1.0 to 10.0°F (0.6 to 5.5°C)
 ③ Duration in mm:ss, range: 0 to 59 minutes in 1 second increments

Air curtain worksheet

Air curtains use relays to switch blowers on to inflate and off to deflate air bags. An air curtain can have from two to six air bags. Each air bag requires a separate relay. For more information, read **Configuring relays for air curtains** on page 33.

The first worksheet is an example only. The set points are not recommendations.

Air curtain	Min vent	Deicing	Drying	Delay ①	Blower	Open set point ②	Close set point ②
Air curtain 1	Yes / No	Yes / No	Yes / No	120	1	70	66
					2	74	72
					3	78	76
					4	82	80
					5		
					6		

① Duration in seconds, range: 1 to 600 (10 minutes) in 1 second increments
 ② Temperature in °F/ °C, range: -13 to 125°F (-25 to 51.7°C)

Air curtain	Min vent	Deicing	Drying	Delay ①	Blower	Open set point ②	Close set point ②
	Yes / No	Yes / No	Yes / No		1		
					2		
					3		
					4		
					5		
					6		

① Duration in seconds, range: 1 to 600 (10 minutes) in 1 second increments
 ② Temperature in °F/ °C, range: -13 to 125°F (-25 to 51.7°C)

Air curtain	Min vent	Deicing	Drying	Delay ①	Blower	Open set point ②	Close set point ②
	Yes / No	Yes / No	Yes / No		1		
					2		
					3		
					4		
					5		
					6		

① Duration in seconds, range: 1 to 600 (10 minutes) in 1 second increments
 ② Temperature in °F/ °C, range: -13 to 125°F (-25 to 51.7°C)

Heating, cooling, and duty cycle relay worksheet

There are three types of heating and cooling relay configurations: cooling, cooling duty cycle, heating, and heating duty cycle. For more information, read:

- ◆ **Configuring relays** on page 31.
- ◆ **Programming relay stages** on page 60
- ◆ **Programming duty cycles** on page 61

Relay	Type	Set point ①	Type ③	Duty cycle	
				ON duration ②	OFF duration ②
Relay 5	Heat	Ventilation	Temperature	01:30	03:00
Relay 1	Heat	Ventilation	:	:	:
Relay 2	Heat	Ventilation	:	:	:
Relay 3	Heat	Ventilation	:	:	:
Relay 4	Heat	Ventilation	:	:	:
Relay 5	Heat	Ventilation	:	:	:
Relay 6	Heat	Ventilation	:	:	:
Relay 7	Heat	Ventilation	:	:	:
Relay 8	Heat	Ventilation	:	:	:
Relay 9	Heat	Ventilation	:	:	:
Relay 10	Heat	Ventilation	:	:	:
Relay 11	Heat	Ventilation	:	:	:
Relay 12	Heat	Ventilation	:	:	:

- ① Temperature in °F/ °C, range: -13 to 125°F (-25 to 51.7°C)
- ② Duration in mm:ss, range: 0 to 59 minutes in 1 second increments
- ③ Temperature based, time based, or persistent

Alarm settings worksheet

The alarm settings for the Supra Touch determine which alarm conditions are enabled, which are disabled, and their settings. All the settings work together to determine how and when the alarm relay activates (in other words, signals an alarm condition).

The alarm relay activates if an alarm condition (one that is enabled) is present for longer than the minimum duration of one minute. The one-minute minimum duration prevents alarms from occurring when the temperature rises or drops for just a few seconds. For more information, read **Programming alarms** on page 43.

Alarm	Status	Set point	Description
High temperature ①	Enabled	Not enabled	The highest temperature to which you can safely allow your facility to rise – cannot be lower than low temperature alarm.
Low temperature ①	Enabled	Not enabled	The lowest temperature to which you can safely allow your facility to fall – cannot be higher than high temperature alarm.
Probe damage	Enabled	Not enabled	----- The temperature sensor is damaged or disconnected.
Inlet 1 jam	Enabled	Not enabled	----- The actuator or curtain cannot move.
Inlet 2 jam	Enabled	Not enabled	----- The actuator or curtain cannot move.

① Temperature in °F/ °C, range: -13 to 125°F (-25 to 51.7°C)

Appendix D: Motor curves

Motor curves provide a way to proportionally increase or decrease speed, regardless of motor manufacturer. For example, a Multifan motor might require 130 VAC to run at 50% RPM, while a Marathon motor might need 100 VAC to run at 50% RPM. Without a motor curve, the Multifan motor would run at a slower RPM than the Marathon motor at the same settings.

Selecting the correct motor curve allows you to set, for example, 50 on the control, and get much closer to 50% RPM on the motor than you would otherwise.



Use manual override or test mode to test and evaluate the operation and performance of your fan motors. For more information, read **Testing sensors and equipment** on page 67.

- ◆ If your fan motors are not running at approximately the correct RPM for the control settings, find your fan in the following table, and then select the motor curve for your fan manufacturer and model/specification.
- ◆ If your fan motor is not listed, use the default motor curve (curve 1). If the default motor curve does not operate your fan motor correctly, test the motor using manual override or test mode while selecting the different curves.

Manufacturer	Diameter (inches)	Model	Specifications	Recommended curve
Aerotech	09	AT09Z2	3350 RPM	2
	36	AT36Z1		4
Airstream	12	APP12F	1/4 HP, 1765 RPM	3
	36	APP36		4
Baldor	14		1/4 HP, 1700 RPM	4
	18		1/3 HP, 1700 RPM	4
	24		1/3 HP, 1140 RPM	4
Canarm	09	PLF9	1/5 HP	4
	12	PLF12		2
	14	PLF14		2
	16	PLF16	1/4 HP	2
	18			2
Choretime (GE)	12		1/3 HP, 1140 RPM	1
Emerson	12		1/6 HP, 3400 RPM	2
Exafan	10		1/4 HP, 1700 RPM	2
	14		1/4 HP, 1700 RPM	2
	16		1/3 HP, 1700 RPM	2
	18		1/3 HP, 1700 RPM	2
	20		0.53 HP, 1700 RPM	2

Manufacturer	Diameter (inches)	Model	Specifications	Recommended curve
	24		0.63 HP, 1700 RPM	2
Franklin	10		1/6 HP, 3450 RPM	2
Leeson	14		1/4 HP, 1625 RPM	2
	18		1/3 HP, 1625 RPM	2
	24		1/3 HP, 1140 RPM	2
	24		1/2 HP, 1625 RPM	2
	36		3/4 HP, 1625 RPM	2
Magnetek	12		1/6 HP, 3300 RPM	2
	12		1/6 HP, 1725 RPM	2
	36		1/2 HP, 840 RPM	4
Marathon	12		1/4 HP, 1625 RPM	2
	24		1/2 HP, 1625 RPM	2
Multifan	18	4E45	1600 RPM	4
	20	4E50		4

Service and technical support

Your dealer will be happy to answer all technical questions that will help you use the Supra Touch. Before contacting your dealer, check the following:

- ◆ Read this manual for information about the feature with which you are having trouble.
- ◆ If you are having a problem using the Supra Touch, look in **Appendix A: Troubleshooting** starting on page 75 and follow the directions for correcting the problem.
- ◆ If you still have a problem with the Supra Touch, collect the following information:
 - ◆ The serial number
 - ◆ Any messages displayed by the Supra Touch
 - ◆ A description of the problem
 - ◆ A description of what you were doing before the problem occurred



- ◇ Phason controls are designed and manufactured to provide reliable performance, but they are not guaranteed to be 100 percent free of defects. Even reliable products can experience occasional failures and the user should recognize this possibility.
 - ◇ If Phason products are used in a life-support ventilation system where failure could result in loss or injury, the user should provide adequate back up ventilation, supplementary natural ventilation, or an independent failure-alarm system. The user's lack of such precautions acknowledges their willingness to accept the risk of such loss or injury.
-

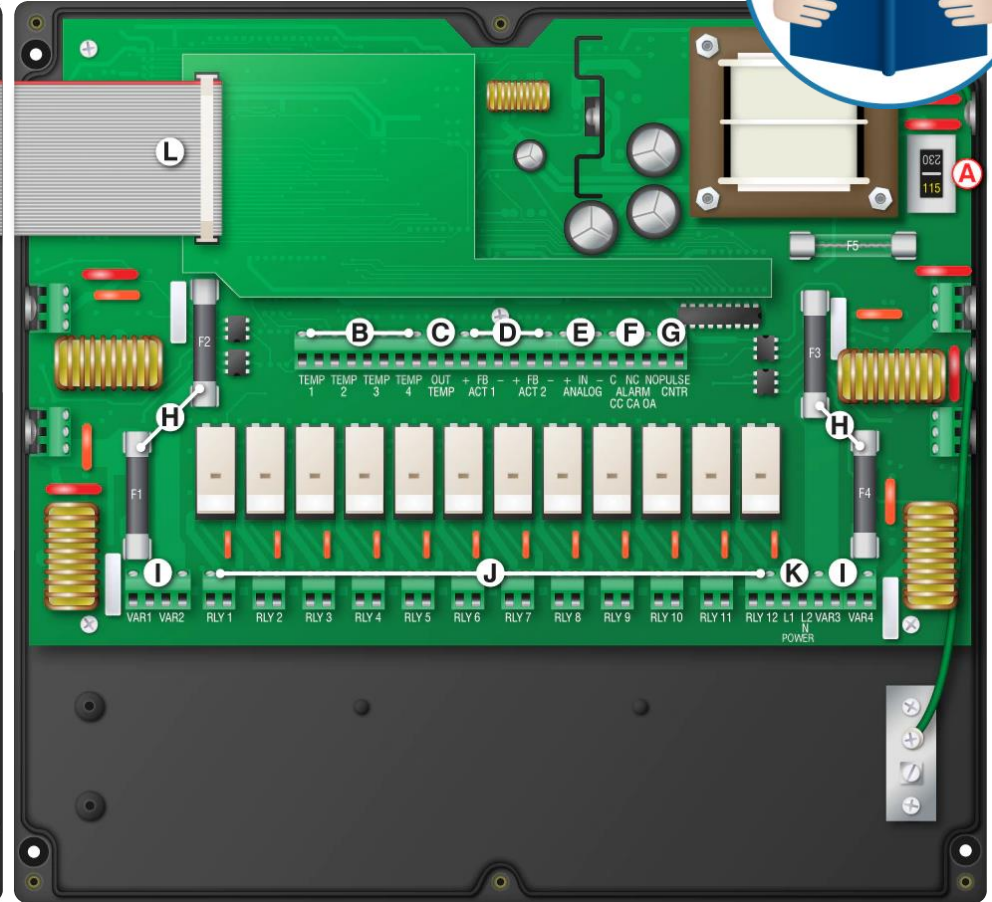
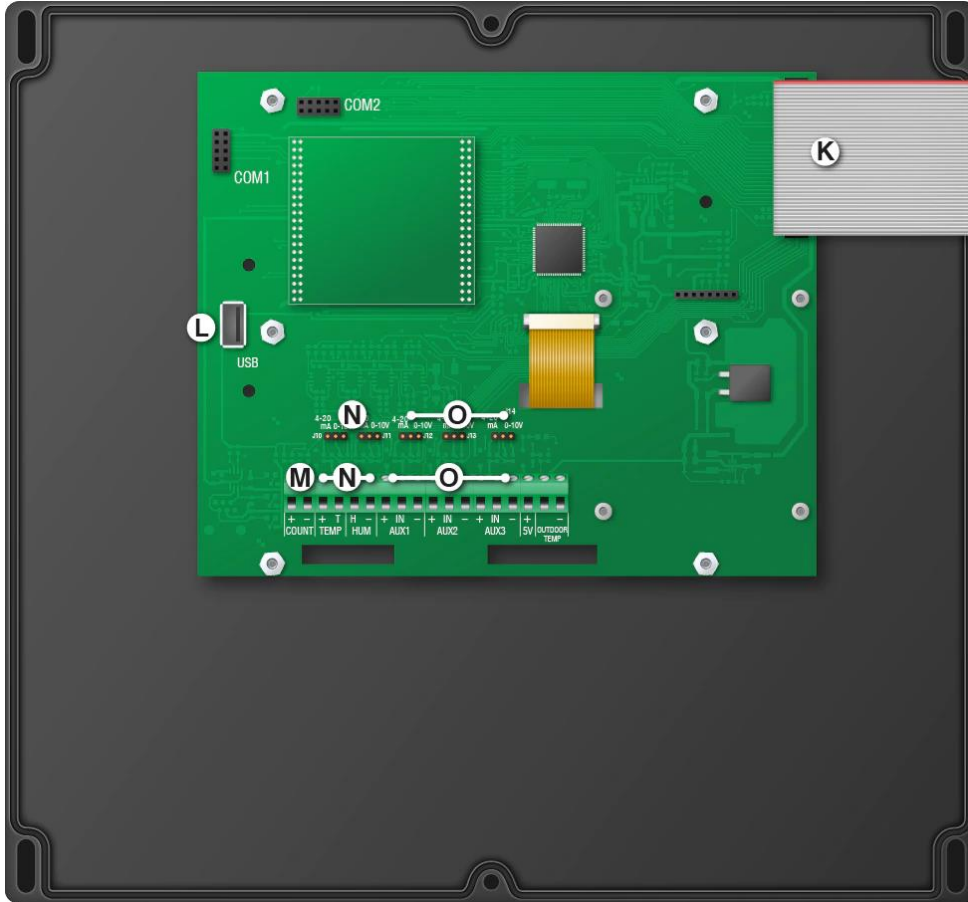
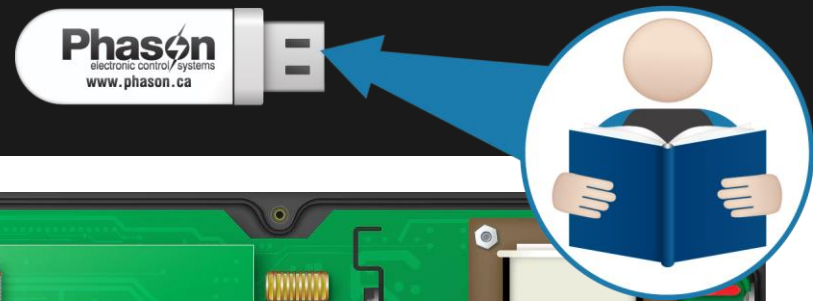

- (A) Voltage switch** ⚠️ Set the switch to the correct line voltage.
- (B) Temperature [TEMP1 to TEMP4]**
Connect the primary 3K Series temperature sensor to TEMP1.
Connect any additional 3K Series sensors to the other terminals.
- (C) Outdoor temperature (OUT TEMP)**
Connect a 3K Series sensor for monitoring outdoor temperatures.
- (D) Actuator feedback [ACT1 and ACT2]**
Connect the feedback potentiometers from actuators that require it.
- (E) Humidity [ANALOG]**
Connect a Phason RHS Relative Humidity Sensor.
- (F) Alarm relay**
Connect an external alarm system or siren.

- (G) Not used**
- (H) Fuses [F1 to F4]**
Fuses for variable stages: F1 for VAR1, F2 for VAR2, and so on.
- (I) Variable stages [VAR1 to VAR4]**
Connect variable speed fans or heating equipment.
- (J) General-purpose relays [RLY1 to RLY12]**
Connect single stage (on or off) equipment to these terminals.
- (K) Incoming power**
Connect the incoming power from the panel.
- (L) Display cable**
Disconnect the cable during installation. Reconnect it when done.

- (M) USB**
Connect a USB drive when saving / loading settings or upgrading.
- (N) Pulse counter (COUNT)**
Connect a WINDSPEED-03 sensor or water meter here.
- (O) DOL 114 [TEMP / HUM]**
Connect a DOL 114 Temperature and Humidity Sensor.
Place the jumpers on the correct pins.
- (P) DOL (AUX1 to AUX3)**
Connect DOL 16 Light, DOL 19 Carbon Dioxide, or DOL 53 Ammonia Sensors. Place the jumpers on the correct pins.

Mounting holes and orientation

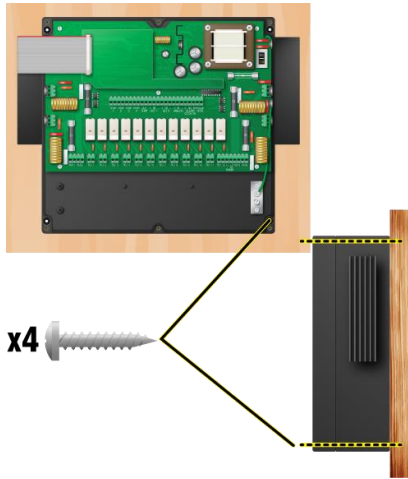

Incoming power

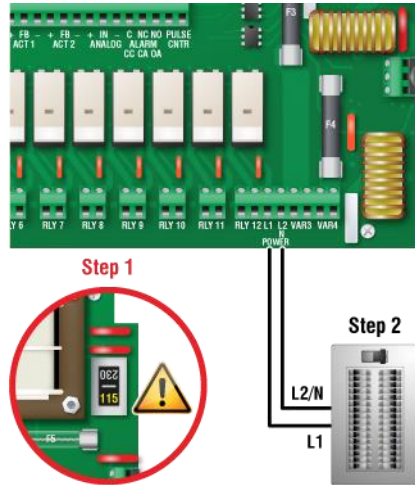

Fixed-speed cooling/heating equipment, air curtains

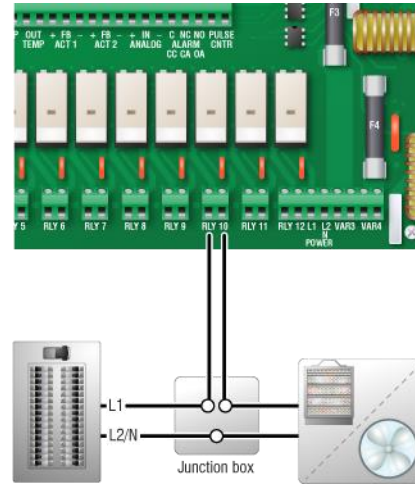

Gas-fired furnace

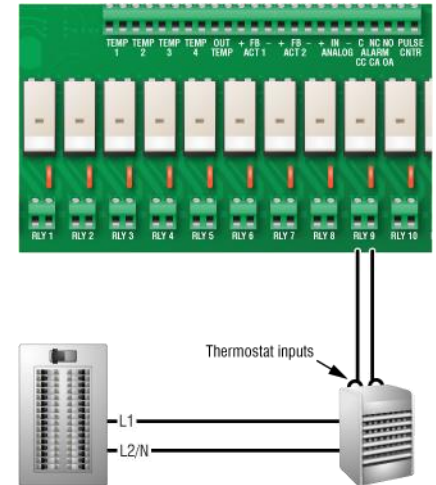

Variable speed fan

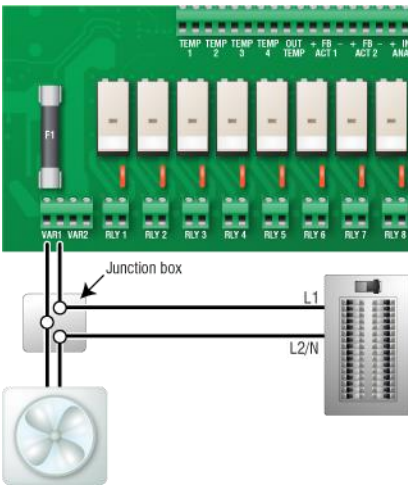

Correct three-phase wiring

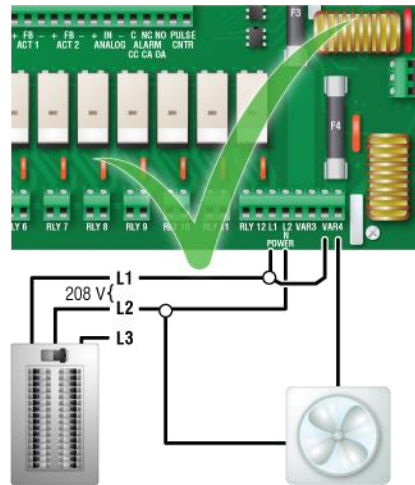

Incorrect three-phase wiring

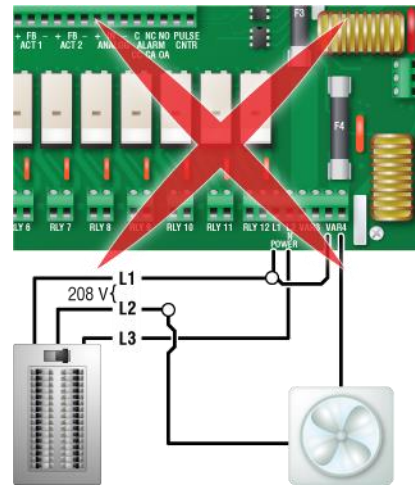

Curtain machine

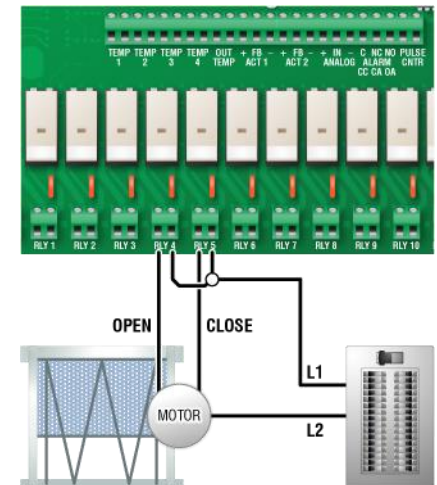

DC-powered actuator

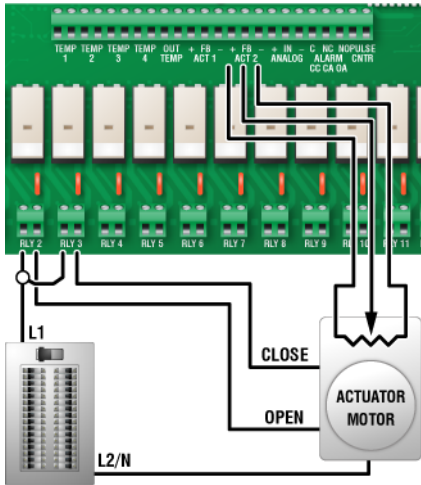

AC-powered actuator

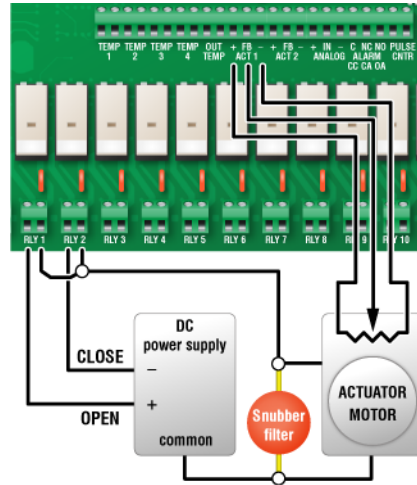

Phason 3K Series temperature sensor

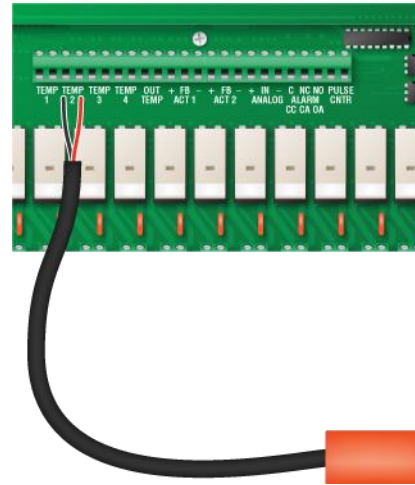

DOL 114 temperature and humidity

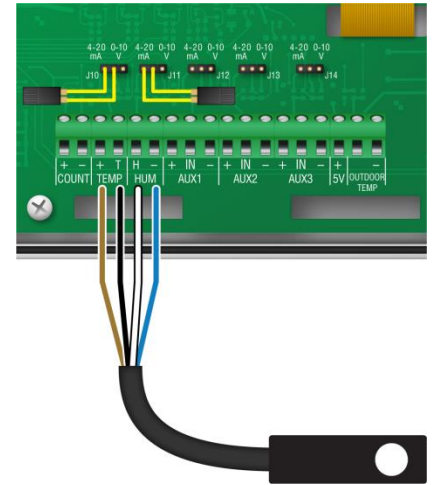

DOL 19 carbon dioxide

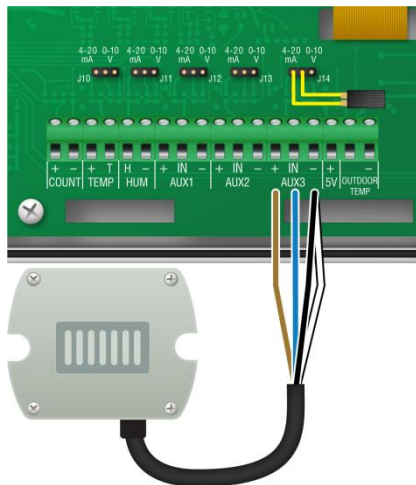

DOL 53 ammonia

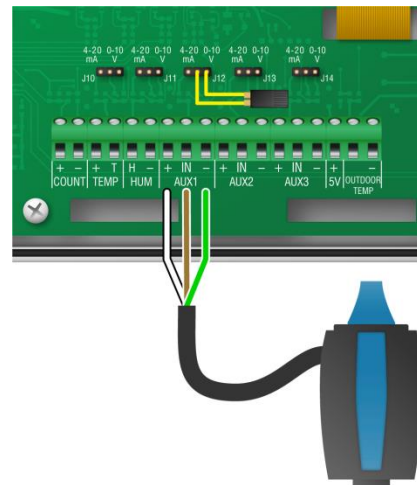

DOL 16 light

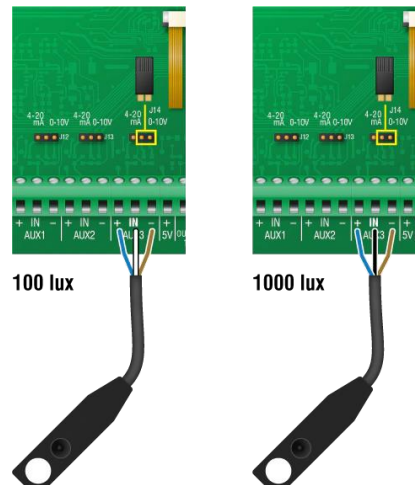

Phason Wind Speed Sensor

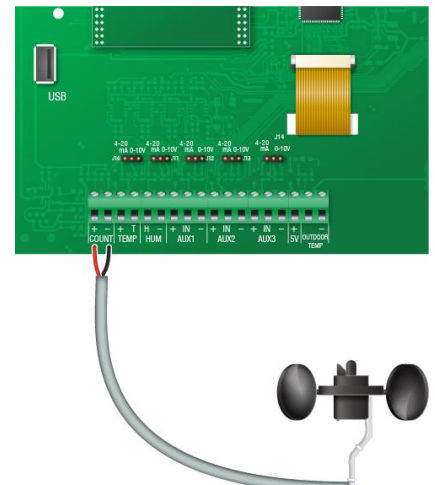

NOTE: Set the output on the DOL19 sensor to 4 to 20 mA. See the DOL19 installation guide.

Phason Relative Humidity Sensor

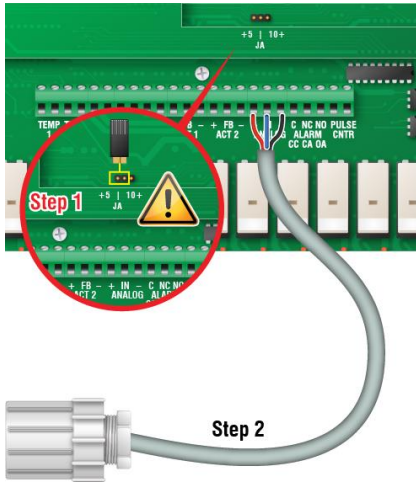

Water meter with dry contact pulse output

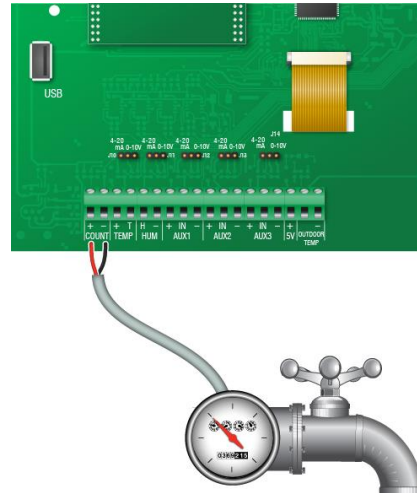

Normally open alarm system

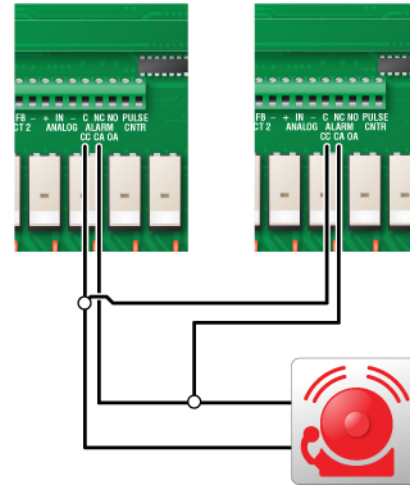

Normally closed alarm system

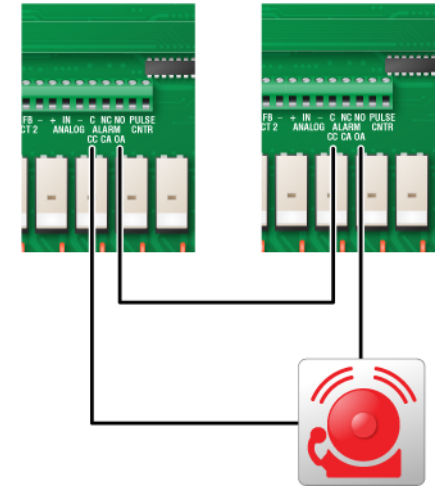

Electrical ratings

Input power

- ◇ 120/230 VAC, 50/60 Hz

Variable stages [4: VAR1 to VAR4]

- ◇ 10 A at 120/230 VAC, general-purpose (resistive)
- ◇ 7 FLA at 120/230 VAC, PSC motor
1/2 HP at 120 VAC, 1 HP at 230 VAC, PSC motor

Fuses [4: F1 to F4]

- ◇ 15 A, 250 VAC ABC-type ceramic

Relay stages [12: RLY1 to RLY12]

- ◇ 10 A at 120/230 VAC, general-purpose (resistive)
- ◇ 1/3 HP at 120 VAC, 1/2 HP at 230 VAC
360 W tungsten at 120 VAC

Alarm relay

- ◇ 0.4 A at 125 VAC; 2 A at 30 VDC, resistive load
- ◇ 0.2 A at 125 VAC; 1 A at 30 VDC, inductive load1